

**THIRD
EDITION**



Union Special
INDUSTRIAL SEWING EQUIPMENT

CATALOG NO. 83R

61400 CLASS

**STREAMLINED HIGH SPEED
LOCKSTITCH MACHINES**

Aid Plant Layout! Boost Production!

PEDESTAL MOUNTED MACHINES

UNION SPECIAL'S pedestal mountings for sewing heads have offered a great many advantages to manufacturers ever since they were introduced as a revolutionary new type of mounting for feed-off-the-arm machines in Classes 35700 and 35800.

In the pedestal mounted type installation, the machine is completely isolated from the base and, where table boards are used, they are completely isolated from the pedestal and from the machine, which makes for smoother, quieter operation. In various cases, the motor may be mounted to the right or to the left under the machine handwheel. Mounting of the motor to the right provides maximum space under machine for the operator.

These new pedestals offer maximum flexibility, convenience, and adaptability to production lines, especially where variations in operation or garment styles are necessary from time to time. The foot treadles are adjustable laterally and the machine mounting bracket is adjustable vertically to suit the individual operator and to provide the most comfortable working position, thus reducing fatigue. The illustrations shown here are just a few of the many styles of machines that Union Special has to offer in the pedestal mounted type installation which manufacturers all over the world have found to be necessary equipment for increasing production.

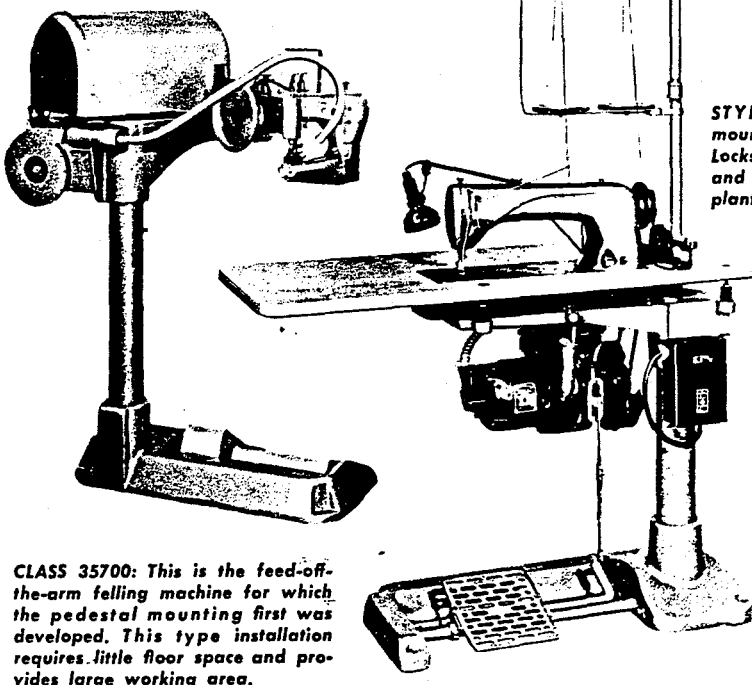

CLASS 35700: This is the feed-off-the-arm sewing machine for which the pedestal mounting first was developed. This type installation requires little floor space and provides large working area.

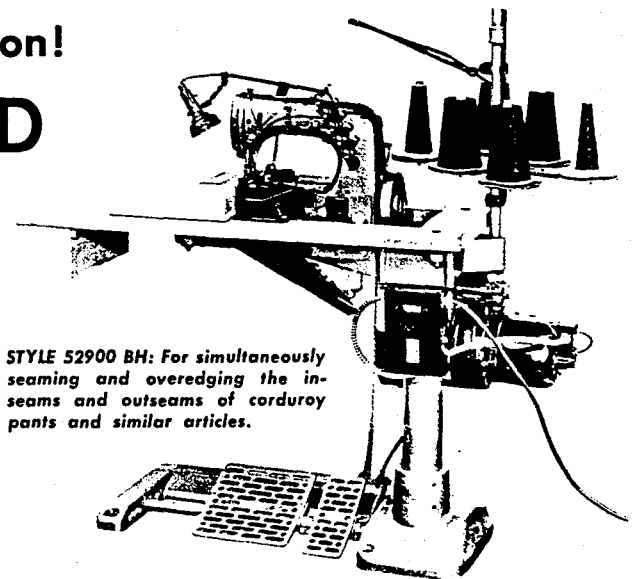

STYLE 52900 BH: For simultaneously seaming and overedging the in-seams and outseams of corduroy pants and similar articles.

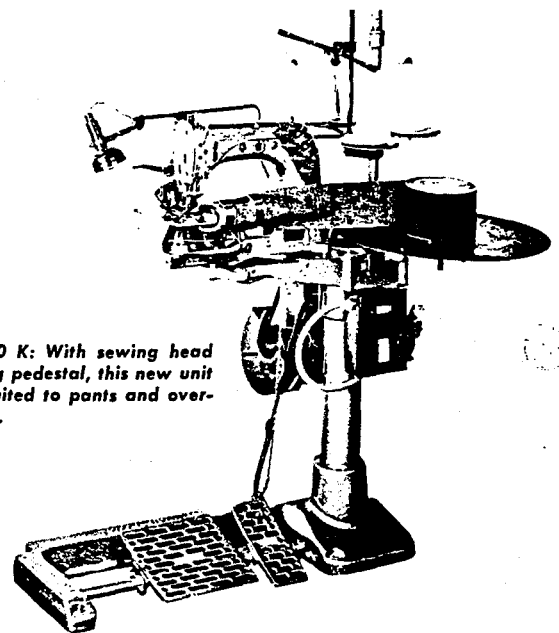

STYLE 54200 K: With sewing head overhanging pedestal, this new unit is ideally suited to pants and overall banding.

STYLE 61400 A: The pedestal mounted, plain feed, single needle Lockstitch makes a most flexible and versatile unit for any sewing plant.

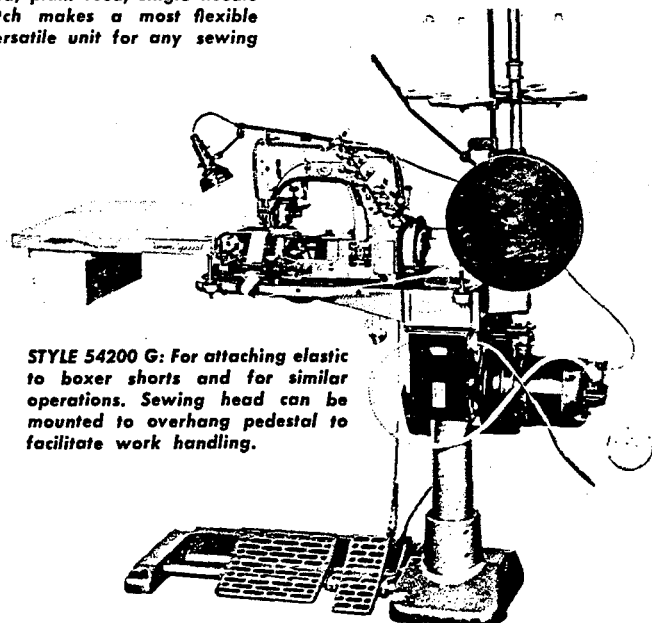

STYLE 54200 G: For attaching elastic to boxer shorts and for similar operations. Sewing head can be mounted to overhang pedestal to facilitate work handling.

Catalog No. 83 R

LIST OF PARTS AND INSTRUCTIONS
FOR
ADJUSTING AND OPERATING

Class 61400

Streamlined Lockstitch

Styles

61400 A	61400 J
61400 B	61400 N
61400 E	61400 P
61400 F	61400 R
61400 G	61400 S
61400 H	61400 AA
	61400 BA

The parts listed in this catalog are
furnished at list prices for repairs only.

Third Edition

Copyright 1955

By

Union Special Machine Co.
Rights Reserved in All Countries

Union Special

MACHINE COMPANY

INDUSTRIAL SEWING MACHINES

CHICAGO

Printed in U. S. A.

March, 1966

Vertical text on the left margin, possibly a page number or header.

Horizontal text line in the upper middle section.

Horizontal text line in the upper middle section.

Horizontal text line in the upper middle section.

Horizontal text line in the upper middle section.

Horizontal text line in the upper middle section.

Horizontal text line in the upper middle section.

Horizontal text line in the upper middle section.

Horizontal text line in the upper middle section.

Horizontal text line in the upper middle section.

Horizontal text line in the upper middle section.

Horizontal text line in the upper middle section.

Horizontal text line in the upper middle section.

Horizontal text line in the upper middle section.

Horizontal text line in the upper middle section.

Horizontal text line in the upper middle section.

Horizontal text line in the upper middle section.

Horizontal text line in the upper middle section.

Horizontal text line in the upper middle section.

Horizontal text line in the upper middle section.

Horizontal text line in the upper middle section.

Horizontal text line in the upper middle section.

FOREWORD

The dominating idea back of "Union Special" is to build the best industrial sewing machines in the world. The new high speed Streamlined Lockstitch machines are a pronounced achievement along these lines. All parts are made to precision gauges insuring complete interchangeability. A few of the outstanding new features are:

1. Streamlined design. Pleasing in appearance, this natural functional design provides greater stability and ruggedness, free from difficult-to-clean recesses.
2. Simplified oiling. Automatically supplies oil to lower main shaft bearings, feed rocker and feed lift bearings and not only eliminates all oil holes in cloth plate but also does away with hand lubrication commonly required below bed plate.
3. Acceleration. The new Streamlined Lockstitch is brought to top speed in an instant - for higher productive rates and lower costs.
4. Push button control, for quick, easy adjustment of stitch length. With a stitch length indicator of the comparison type, using letters as a means of reference to predetermine stitch lengths.

It is our constant aim to furnish carefully prepared information that will enable the customer to secure all possible economies and advantages from the use of Union Specials. The following pages contain valuable operating and adjusting data and illustrate and describe the parts for Styles in Class 61400 Streamlined Lockstitch machines.

An additional catalog, containing information relative to these machines, and which will be furnished on request, is listed below:

Catalog No. 45 N Needle Manual

Union Special representatives will be found in all manufacturing centers, ready to cooperate with you to plan and estimate requirements.

Union Special MACHINE COMPANY

Engineering Department

APPLICATION OF CATALOG

This catalog applies only to the standard styles of machines as listed herein. It can also be applied with discretion to the special machines in Class 61400. All references to directions, such as right and left, front and back, etc., are taken from the operator's position while seated at the machine..

IDENTIFICATION OF MACHINE

Each Union Special carries a style number which is stamped in the name plate on the machine. Style numbers are classified as standard and special. Those which are standard have one or more letters suffixed, but never contain the letter "Z". Example: "61400 A". Style numbers containing the letter "Z" are special.

Styles of machines similar in construction are grouped under a class number which differs from the style number in that it contains no letters. Example: "61400".

STYLES OF MACHINES IN CLASS 61400 STREAMLINED LOCKSTITCH

- 61400 A For plain seaming, 1 9/64 inch needle bar travel. Accessories No. 29480 AJ included. Plain edge guide No. 61203 or 61203 A and attaching screw No. 22551 A or three-way edge guide No. 61303 E with attaching screw No. G26 will be furnished gratis when specified. All other guides and attachments are extra. (Specify feed dog, presser foot, throat plate, attachments, guides, stitches per inch, thread number, needle type and size.)
- 61400 B Same as Style 61400 A, except it has 1 13/64 inch needle bar travel.
- 61400 E Non-adjusted machine prepared to receive Columbia pinking attachment, 1 9/64 inch needle bar travel, no sewing parts included. Accessories No. 29480 AJ included. (Specify needle type and size.) (NO LONGER AVAILABLE)
- 61400 F Same as Style 61400 E, except it includes sewing parts and Columbia pinking attachment for plain seaming and simultaneous pinking operations on light to medium work, such as house dresses, slips, etc. (Specify needle type and size.) (NO LONGER AVAILABLE)
- 61400 G Non-adjusted machine prepared to receive Lewis pinking attachment, 1 9/64 inch needle bar travel, plain feed, no sewing parts included. Accessories No. 29480 AJ included. (Specify needle type and size.) (NO LONGER AVAILABLE)
- 61400 H Same as 61400 G, except it includes sewing parts and Lewis pinking attachment, for plain seaming and simultaneous pinking operation on light to medium work such as house dresses, slips, etc. (Specify needle type and size.)
- 61400 J Same as Style 61400 A, except equipped with a quick stitch change mechanism that will produce two predetermined stitch lengths by instant adjustment.
- 61400 N Equipped with power driven top roller feed to right of needle, 1 9/64 inch needle bar travel, for attaching collar bands to dress shirts and hemming tails of sport or dress shirts, etc. Accessories No. 29480 AJ included. (Specify feed dog, presser foot, throat plate, feed roller, guides, stitches per inch, thread number, needle type and size.)
- 61400 P Equipped with power driven top roller feed to rear of needle, 1 9/64 inch needle bar travel, for attaching sleeve facings to work and dress shirts. Accessories No. 29480 AJ included. (Specify feed dog, presser foot, throat plate, feed roller, guides, stitches per inch, thread number, needle type and size.)
- 61400 R Same as Style 61400 N, except it has 1 13/64 inch needle bar travel. (Specify feed dog, presser foot, throat plate, feed roller, guides, stitches per inch, thread number, needle type and size.)
- 61400 S Same as Style 61400 P, except it has 1 13/64 inch needle bar travel. (Specify feed dog, presser foot, throat plate, feed roller, guides, stitches per inch, thread number, needle type and size.)
- 61400 AA Same as Style 61400 A, except without accessories. We do furnish one extra bobbin, spool pin, two hinge studs and two No. 22585 A screws for attachment.
- 61400 BA Same as Style 61400 B, except without accessories. We do furnish one extra bobbin, spool pin, two hinge studs and two No. 22585 A screws for attachment.

ILLUSTRATIONS OF STANDARD LOCKSTITCH MACHINES

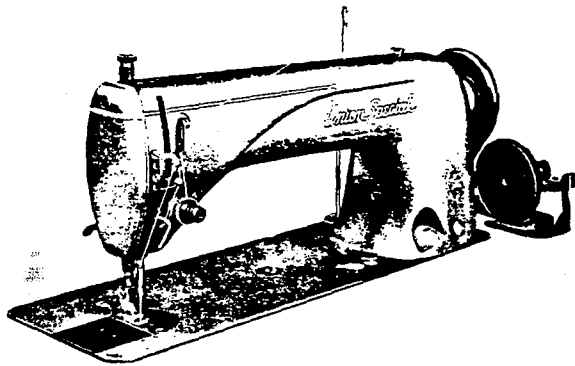

61400 A
61400 B

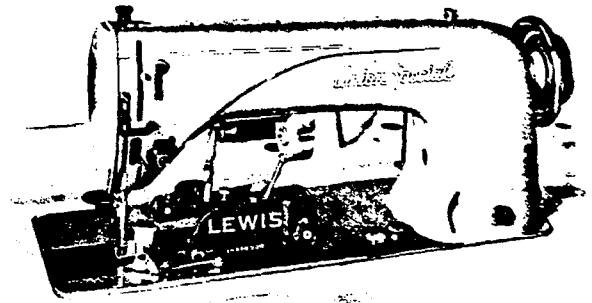

61400 G

Note: See page 81 for pinker
repair parts.

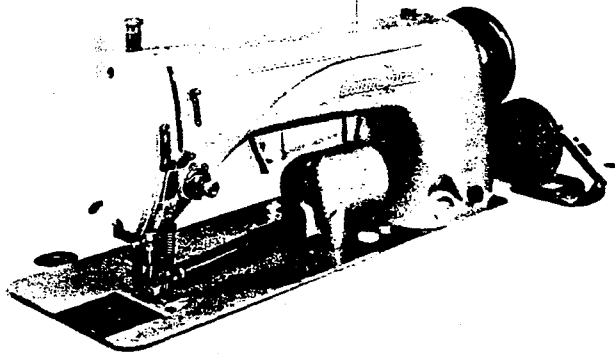

61400 N
61400 R

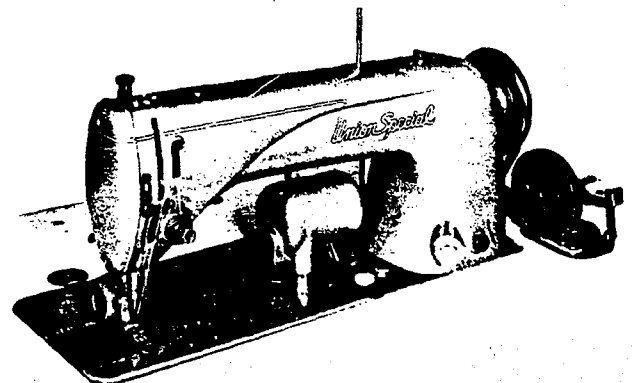

61400 P
61400 S

Other equipment which may be applied to Union Special Lockstitch machines is the Fowler Trimmer. This attachment is furnished by the Fowler Machine and Attachment Company, 1128 Broadway, Brooklyn, N. Y.

Your inquiries regarding this equipment will be promptly attended to. The illustration below shows the Fowler Trimmer installed on a Style 61100 C skirt taping machine.

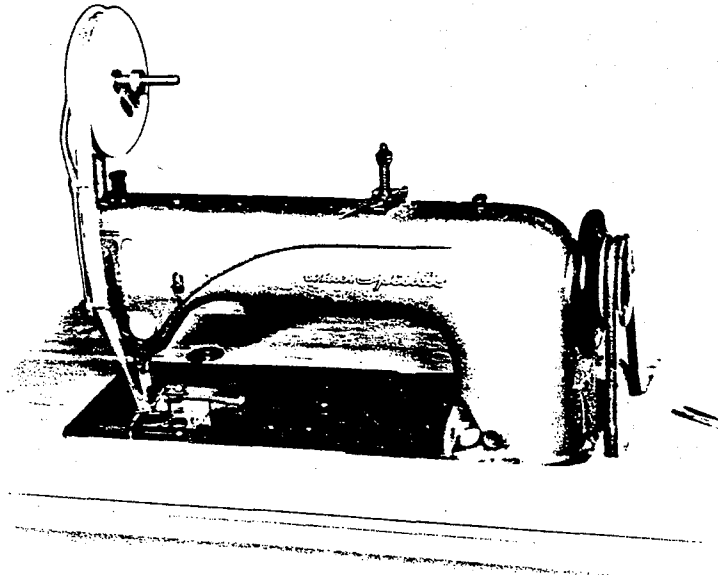

Fowler Trimmer

**INSTRUCTIONS FOR ASSEMBLING ACCESSORIES 29480 AJ
OR 29480 CG & ISOLATORS 29480AK ONTO TABLEBOARDS
21371NB, 21371ND (ALL LENGTHS)**

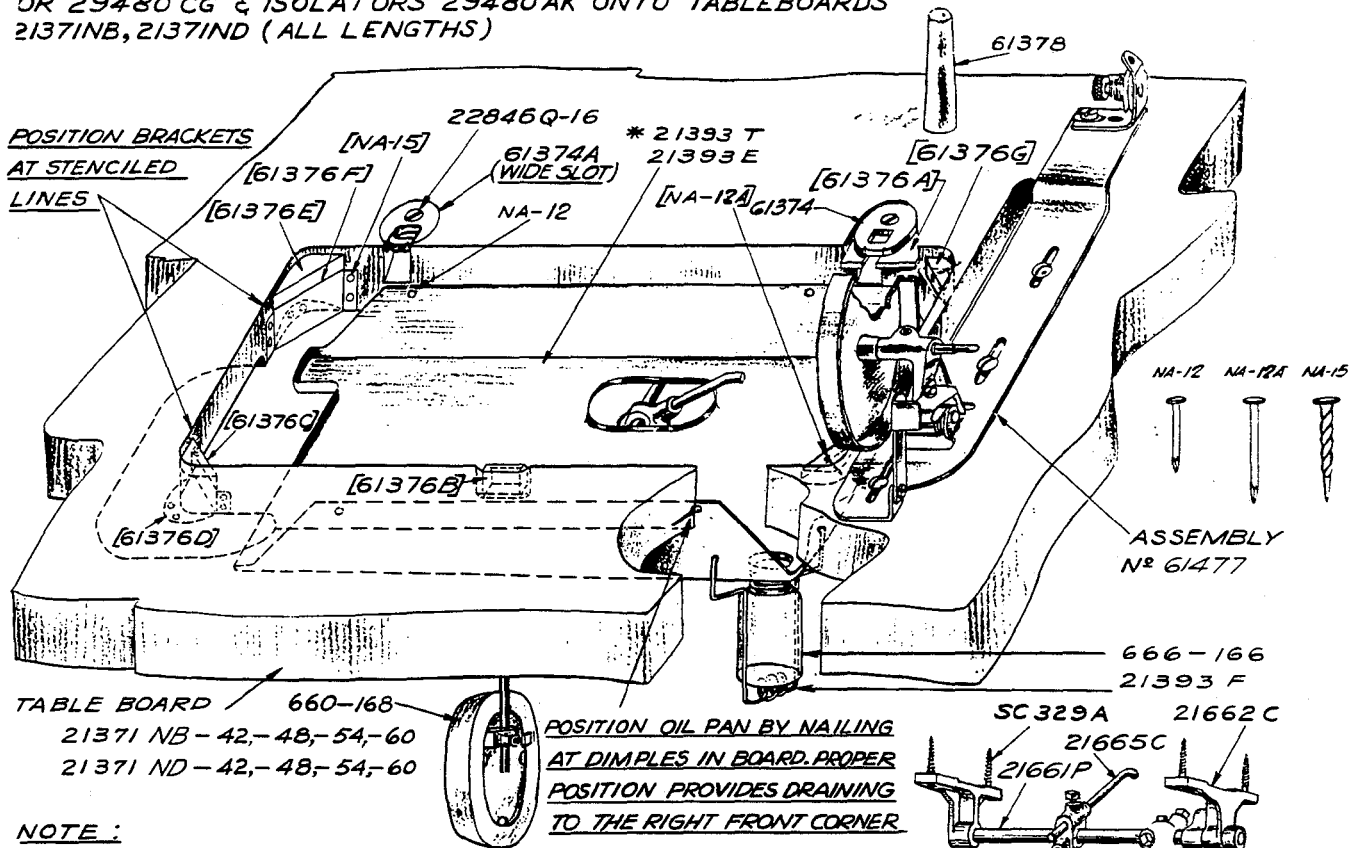
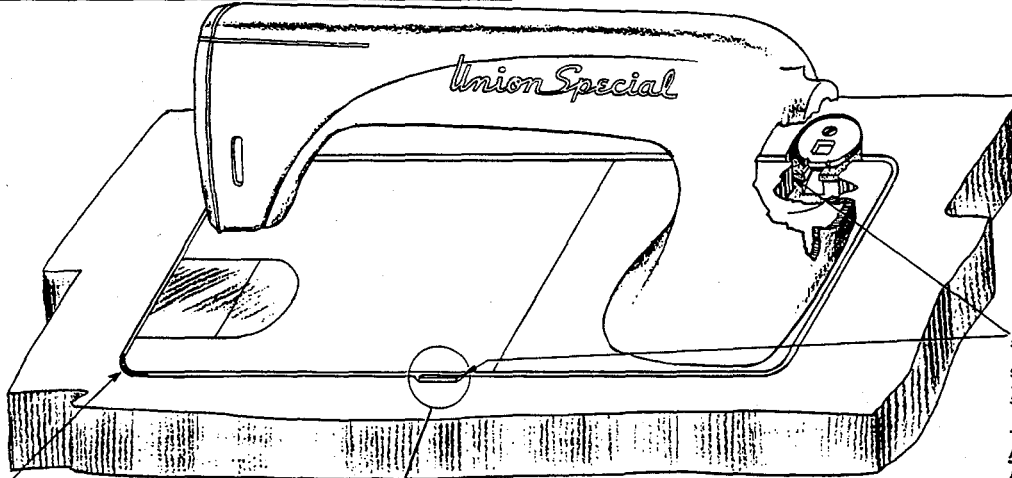

TABLE BOARD 660-168
21371 NB - 42, -48, -54, -60
21371 ND - 42, -48, -54, -60

NOTE :

PART NUMBERS ENCLOSED IN BRACKETS ARE NOT INCLUDED WITH ACCESSORIES 29480AJ BUT ARE FURNISHED SEPARATELY AS 29480 AK.



END OF ISOLATORS MAY BE TRIMMED TO BRING CLOTH PLATE FLUSH WITH TABLE BOARD

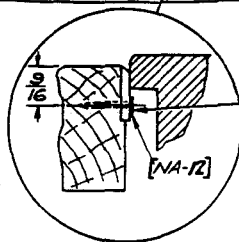

THE TWO NAILS SECURING LEATHER ISOLATOR TO TABLE BOARD MUST BE LOW ENOUGH TO CLEAR BED

PERIMETER OF BED MUST CONTACT THE TWO LEATHER ISOLATORS ONLY. IF BED CONTACTS BOARD, VIBRATION WILL BE TRANSMITTED

* 21393 T INCLUDED WITH 29480 CG FOR 61900 WITH PINKER

INSTALLING

Each machine before it leaves the factory is sewed off, inspected, and carefully packed. When the machine reaches the customer it is ready for service. Because of all the precaution taken by those who handle the machine, the customer needs only to place it in its proper position in the table and make only the ordinary settings to adapt the machine to the material he wishes to sew.

ASSEMBLY PARTS

A bag of assembly parts, consisting of one spool pin, one extra bobbin, two hinge studs, and two screws for holding miscellaneous attachments to the bed plate is packed with each machine.

After unpacking the machine assemble the spool pin (K, Fig. 3).

Push the hinge studs into position in the holes provided at the rear of the machine. The studs are slotted so that a tight fit can be easily made.

STANDARD ACCESSORIES

Also included with each machine is a box of standard accessories containing one bobbin winder assembly, one drip pan, one oil drain jar and clamp spring, one knee lifter assembly and rubber pad, one machine rest pin, two hinge plates and screws, four felt pads and necessary nails. These parts are indispensable when setting up the machine.

TABLE TOPS

Lockstitch machines are installed in table tops prepared with cut out, so that the bed plate is flush with the top of the table.

Standard table tops are available for isolated mounting on all types of installations and drives.

Isolated mounting parts are not included with table tops and must be ordered separately. The installation of isolated mounting parts is shown in (Fig. 1). For table tops not prepared for isolated mounting, felt pads are furnished with the accessories for isolating. The nails for these pads should be driven horizontally as indicated on the right end of cut-out (Fig. 1).

When assembling the hinge plates to the table tops, be sure to locate them as accurately as possible, so that the hinge studs, attached to the machine, can swing properly in the plate.

Special care should be taken that machine does not contact the sides of the cut-out at any point.

KNEE PRESS

The knee press is attached to Union Special table tops at the location designated by punch marks on the underside. For other boards locate the knee press so that the center of the shaft is 8-1/4 inches from the right side of the cut-off. The knee press assembly should appear as in (Fig. 2).

DRIP PAN

The drip pan is attached to Union Special table tops at the indentation marks on the inside of the cut-out, using the nails furnished with the accessories (Fig. 1). For other table tops, the drip pan should be set high enough to clear the knee press and low enough to clear the bottom of the machine. It should be laterally located so that it is directly under the base of the machine.

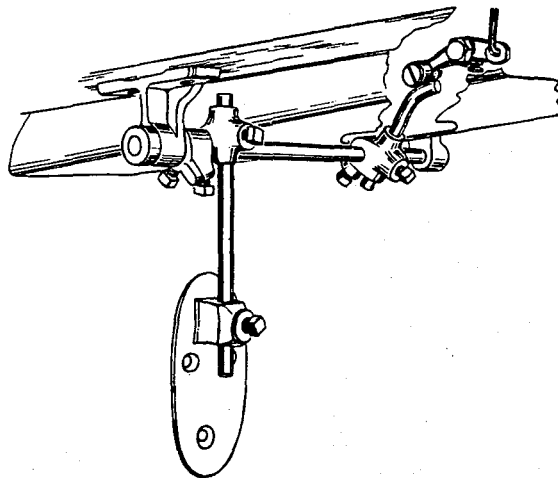

Fig. 2

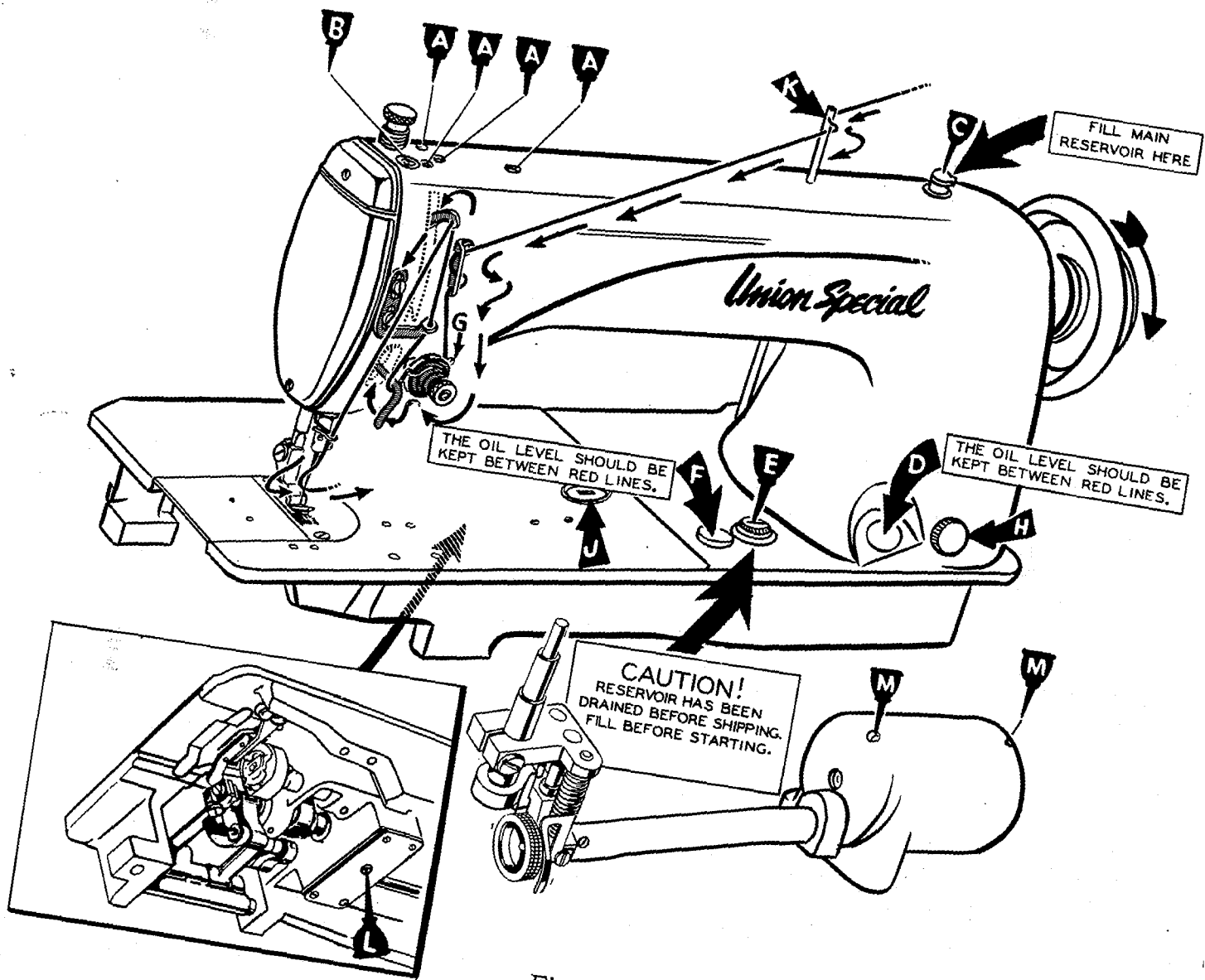

Fig. 3

INSTALLING (Continued)

BOBBIN WINDER

The bobbin winder should be secured to the table top so that its pulley will be located directly in front of the sewing machine belt and will bear against the belt when in operation. The base of the winder has two elongated attaching holes, which allows the mechanism to be moved closer to or farther away from belt as needed. The pulley of the winder, when in operation should exert only enough pressure against the belt to wind the bobbin. Regulation and operation of the bobbin winder is described under "Threading and Winding the Bobbin".

BELTS

These machines are equipped to use either No. 1 "V" or round belt.

LUBRICATION

CAUTION!!

The oil has been drained from the main reservoir, the hook shaft gear case, and the hook oil reservoir before shipment and these reservoirs must be filled before starting to operate. Lubricate machine thoroughly in accordance with instructions and run slowly for several minutes to distribute the oil to the various parts. Full speed operation can then be expected without damage.

RECOMMENDED OILS

Use a straight mineral oil of a Saybolt viscosity of 200 to 250 seconds at 100° F. in hook oil reservoir, main reservoir, and hook shaft gear case. This is equivalent to Union Special oil specification No. 83.

Stainless water white straight mineral oil of the same viscosity as that described in the preceding paragraph can be used in the hook oil reservoir, the stainless oil is Union Special specification No. 86.

Oils conforming to specification No. 83 or 86 may also be used in the manually oiled places.

For trouble free operation, oil the machine as indicated in the diagram (Fig. 3).

With needle bar at the top of its stroke, oil the holes (A) twice daily. In oiling hole (B), very little oil should be used and only around the outer edges of the needle bar. Do not put oil into the hole in the needle bar as it will flow out when machine is operated at high speed. A can of oil, No. 28604 J, is included with the accessories packed with the machine. It contains a sufficient quantity to fill all the reservoirs. The main reservoir is filled through oil cup (C) and the supply is usually replenished about twice a month. However, the oil level should be checked from time to time and kept between the lines on the gauge (D).

The hook oil reservoir is filled at plug screw (E) and its level should be checked twice daily and kept between the lines on the gauge (F).

The hook shaft gear case is filled at the plug screw hole (L). A quantity of oil sufficient to bring the level up to the plug screw hole, when the machine is tilted back against the rest pin, should be used. Remove plug screw and check the level of oil about every six months.

On Styles 61400 N, 61400 P, 61400 R, 61400 S, holes (M) should be oiled sparingly each day.

CAUTION!!

Do not use a compounded oil in the hook oil reservoir, feeding drive shaft gear case, or hook shaft gear case, as these oils separate and froth.

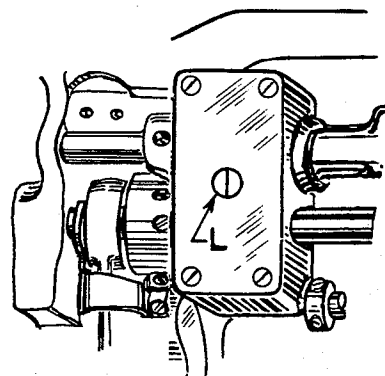

Fig. 4

CAUTION!!

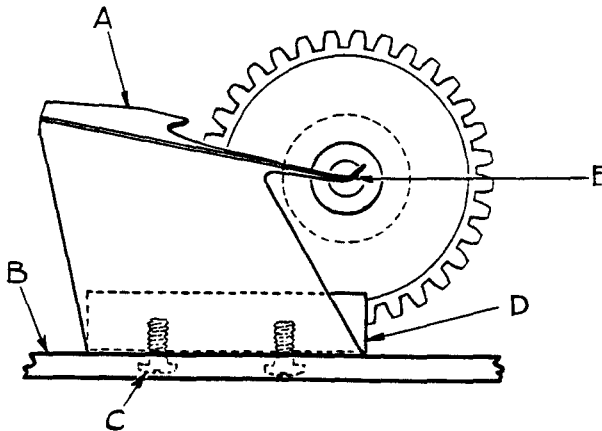

Fig. 5

Lubrication of the mechanism below the bed plate is automatically accomplished through the feed driving shaft which is tubular. Oil is introduced into the shaft at the gear end by means of an oil distributing plate (A, Fig. 5) which is secured to the large gear case cover (B) by means of two screws (C) and retaining block (D).

Should it ever become necessary to remove any of the parts from the gear case, it is imperative that the adjustment of the oil distributing plate be checked very carefully. This can be done by removing the large plug screw at the right end of the gear housing and looking through the hole. The low point of the oil distributing plate must be even with or slightly below the center of shaft (E) and just touching it. This is a very important adjustment as the functioning of the automatic lubrication of the lower part of the machine depends upon it.

NEEDLES

TYPE NUMBERS AND SIZES

Each needle has a type number and size number. The former denotes the kind of shank, point, length of groove, finish and other details. The latter denotes the largest diameter of the blade, measured in thousandths of an inch across the eye, and is stamped in the needle shank. Collectively, the type number and the size number is the complete symbol.

To have orders promptly and accurately filled, the empty package, a sample needle, or the type and size number should be given. See marks on packages. A complete order would read as follows: "1000 Needles Type 183GNS, Size 040".

Needle Types 180GNS, 180GPS are recommended for Styles 61400 B, 61400 R, 61400 S. Needle Types 183GNS, 183GPS are recommended for Styles 61400 A, 61400 E, 61400 F, 61400 G, 61400 H, 61400 N, 61400 P.

TYPE NO.

DESCRIPTION AND SIZES

180GNS	Round shank, round point, lockstitch, short length, ball eye, single groove, struck groove, short spot, ball point, chromium plated - sizes 032, 036, 040, 044, 048, 054, 060
180GPS	Round shank, round point, lockstitch, short length, ball eye, single groove, struck groove, short spot, chromium plated - sizes 028, 032, 036, 040, 044, 048, 054, 060
183GNS	Round shank, round point, lockstitch, extra short length, ball eye, single groove, struck groove, short spot, ball point, chromium plated - sizes 029, 032, 036, 040, 044
183GPS	Round shank, round point, lockstitch, extra short length, ball eye, single groove, struck groove, short spot, chromium plated - sizes 029, 032, 036, 040, 044

SELECTING THE SIZE OF THE NEEDLE

The strength requirement of the seam produced is largely dependent on the size of the thread employed. The quality of the work desired is largely dependent on the size of the needle employed. On heavy work, the penetration of which requires a sturdy needle, it is advisable to use a comparatively large size needle for a given size thread.

The following table shows the preferred size of needle for a given size and kind of thread. The choice, however, should give consideration to the factors referred to above, which may dictate the selection of a needle size slightly larger or smaller than the size specified.

NEEDLES (Continued)

SELECTING THE SIZE OF THE NEEDLE (Continued)

<u>COTTON THREAD SIZE</u>	<u>MERCERIZED THREAD SIZE</u>	<u>NEEDLE SIZE</u>
20	-	060
30	B	054 to 060
36	A	048 to 054
40	A	044 to 048
50	O	044 to 048
60	OO	040 to 044
70	OOO	036 to 040
80	OOOO	032 to 036
90	OOOO	032 to 036
100	-	028 to 032

OPERATOR'S INSTRUCTIONS

THREAD

While the direction of the twist in the bobbin thread is immaterial, the direction the hook rotates favors the use of a left twist thread in the needle. To determine the direction of twist grasp a short length of thread between the thumb and forefinger of both hands. Turn the thread away from you with the right hand. If the strands unwind it is a left twist; if the strands wind tighter it is a right twist.

SELECTING THE HOOK ASSEMBLY

Due to variations in the sizes of needle thread used, two hook assemblies have been provided. For sizes 30-4 to 16-4 thread, the use of No. L628 hook assembly is recommended and for sizes smaller than 30-4 No. 29474 F should be used.

REMOVING THE BOBBIN CASE

To remove the bobbin case, turn handwheel in operating direction until the needle reaches its highest position. Using the left hand reach under the table, open the bobbin case latch (A, Fig. 6) and pull the bobbin case out of the sewing hook.

Opening the latch retains the bobbin in the case. When the latch is closed the bobbin is released and can readily be removed.

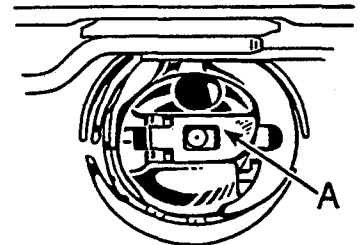

Fig. 6

WINDING THE BOBBIN

Thread the bobbin winder by leading the thread from the supply down through the eyelet (A, Fig. 7), down between the tension discs, and under the tension post. Press an empty bobbin on the winder shaft (B) up to the stop, wind the end of thread around the bobbin a few turns in a clockwise direction, and press downwardly on hand lever (C) until pulley is moved into contact with machine belt, and is locked in that position. When the machine is operated, the bobbin will be rotated and filled until the thread engages the automatic throw-out member, which disengages the pulley. The extent to which the bobbin is filled can be varied by regulating the screw (D).

The tension post bracket is mounted on the winder base, and can be shifted from left to right by loosening screw (E) so that any tendency of the bobbin to wind unevenly may be readily corrected.

OPERATOR'S INSTRUCTIONS (Continued)

WINDING THE BOBBIN (Continued)

The purpose of the bobbin winder is to assure the operator of a full bobbin at all times. When the bobbin in the machine is used up, replace it with a full one and begin to wind the empty bobbin immediately. Bobbins can be rewound while the machine is sewing.

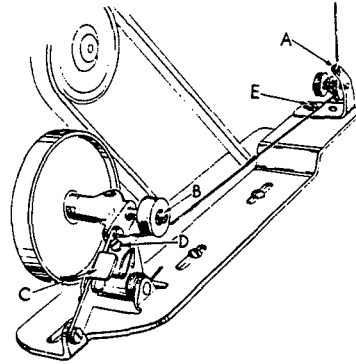

Fig. 7

THREADING THE BOBBIN CASE

The bobbin case should be held between the thumb, second and third fingers of the left hand (A, Fig. 8).

The bobbin should be held between the thumb and forefinger of the right hand (B) with the thread coming off the bottom of the bobbin.

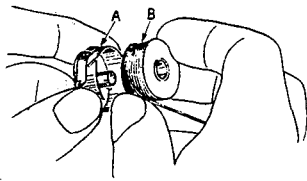

Fig. 8

Place the bobbin in the bobbin case. In one continuous motion with the thumb and forefinger of the right hand draw the bobbin thread through the diagonal slot in bobbin case (A, Fig. 9) under the tension spring and into corner of spring (B). Note the direction of the rotation of the bobbin as the end of the thread is pulled when looking at the bobbin case from the back. The bobbin should rotate counterclockwise.

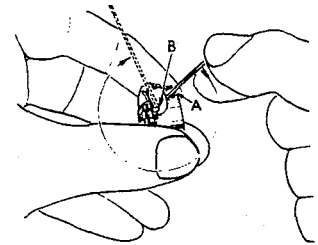

Fig. 9

REPLACING THE BOBBIN CASE

Have the needle bar at its highest position, allow about two and one half inches of thread to hang free. The bobbin case latch should be opened with the left hand and by reaching under the table and through the opening in the table it should be placed part way into the sewing hook. The latch should then be released and bobbin case snapped into position.

INSERTING THE NEEDLE

Insert the needle in the needle bar as far as it will go, with the spot or scarf toward the right facing the handwheel. Tighten the set screw securely.

The cross hole in needle bar, about 1/4 inch from end (A, Fig. 10) is to show the operator when the needle has been inserted as far up as it will go, and to provide a means for cleaning accumulated lint from needle hole so needle will seat properly.

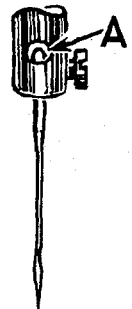

Fig. 10

OPERATOR'S INSTRUCTIONS (Continued)

THREADING THE NEEDLE

Threading diagram (Fig. 3) shows the places where the needle thread passes. Please note that the needle thread passes through the needle eye from left to right.

PREPARATION FOR SEWING

With the left hand hold the end of the needle thread, leaving it slack, and turn the handwheel in operating direction until the needle moves down and up again to its highest position. Pull up the needle thread and the bobbin thread will come up with it through the needle hole in throat plate. Draw both threads under the presser foot.

TENSIONS

A perfect stitch is one in which the needle thread and bobbin thread are locked together in the center of the material being sewed. A stitch of this kind is secured by regulating the tensions on both threads.

BOBBIN THREAD TENSION

The tension on the bobbin case is applied by means of a set screw (A, Fig. 11) which regulates tension spring (B). The tension on the spring is correct when it is just sufficient to hold the case and bobbin, suspended by the bobbin thread.

Remove the bobbin case from the bobbin case holder and turn set screw in spring in a clockwise direction to apply more tensions or counterclockwise to release tension.

When the bobbin thread tension is correct it rarely becomes necessary to make any changes as varying the needle thread tension will usually attain a good stitch.

NEEDLE THREAD TENSION

The needle thread tension is varied by turning the tension regulating nut (G, Fig. 3). Turning the nut in a clockwise direction increases the tension and counterclockwise decreases the tension. This should not be done when the presser foot is in its raised position, and is generally done while the machine is sewing on a piece of scrap material.

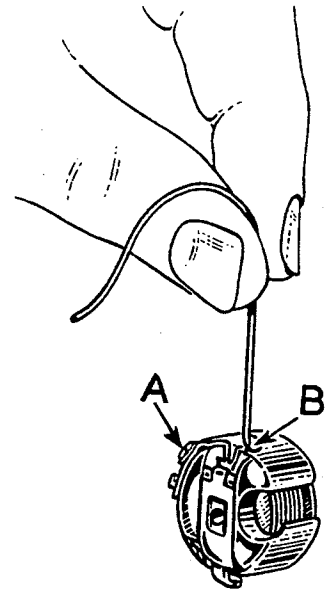

Fig. 11

TO CHANGE THE STITCH LENGTH

Press plunger (H, Fig. 3) in firmly. While holding plunger in, turn handwheel in operating direction until stitch regulating finger is felt to drop into the slot of feed eccentric. Continuing to hold the plunger in, turn handwheel in operating direction to increase the stitch length and in opposite direction to decrease the stitch length.

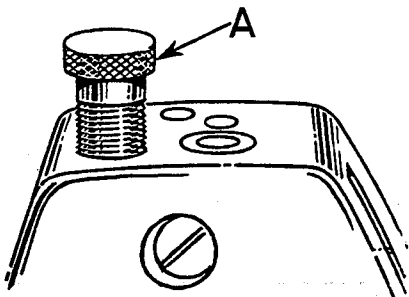

Fig. 12

Comparative stitch lengths are indicated by the graduations on the dial (J) in bed plate, ranging from S (Short) to L (Long). Release the plunger.

PRESSURE ON MATERIAL

The presser spring should exert only enough pressure to make the work feed uniformly. To increase the pressure on the presser foot turn the presser spring regulator (A, Fig. 12) in clockwise direction. Turning the regulator counterclockwise decreases the pressure.

MECHANIC'S INSTRUCTIONS

SETTING THE NEEDLE BAR TO HEIGHT

The lower needle bar bushing, the one to which the needle bar is timed, is set at the factory, the distance from the bottom of bushing (B, Fig. 13) to the throat plate seat is $2\frac{9}{32}$ inches.

The four lines engraved on the needle bar are used in setting the bar to height and are referred to as timing lines. The upper two lines are used with the extra short length Type 183 GC or 183 GL needles which are recommended for Styles 61400 A, 61400 E, 61400 F, 61400 G, 61400 H, 61400 N, 61400 P.

The lower two lines are used with the short length Type 180 GL needles which are recommended for Styles 61400 B, 61400 R, 61400 S.

When the needle bar is at its lowest position the upper timing line (A) of the pair selected, dependent on the needle being used, should be even with the lower edge of the lower needle bar bushing (B). To change the position of the needle bar turn the handwheel until the needle bar is at its lowest position, then loosen clamp screw (D) and move the bar to the proper timing line. Keeping the needle bar link at its lowest position, retighten screw securely.

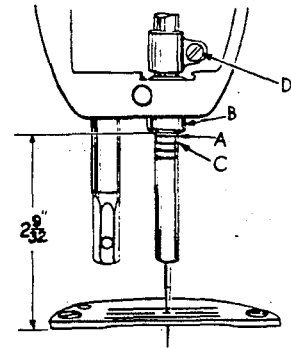

Fig. 13

The illustration (Fig. 13) shows the proper setting of the needle bar on Style 61400 A using extra short needles Types 183GNS or 183GPS. The setting of the needle bar on Style 61400 B using short needles Types 180GNS or 180GPS is accomplished in the same manner except that the lower pair of timing marks on the needle bar is used.

TIMING THE HOOK

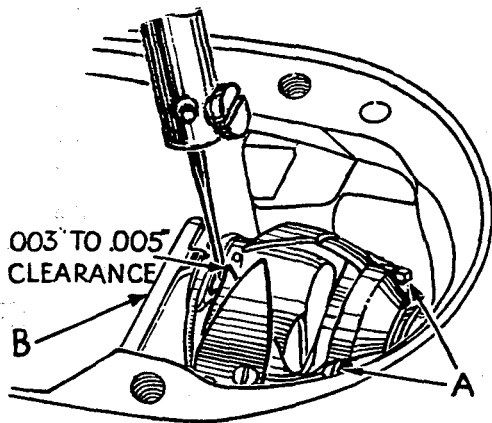

Fig. 14

tighten the set screw opposite the hook point securely. Then tighten two remaining screws securely and recheck the timing of hook with the needle at which time the top of the eye of the needle should be about $\frac{1}{64}$ inch below the bottom of the hook point. If this condition does not exist, recheck the setting of the needle bar bushing in relation to the throat plate seat.

Adjust the bobbin case holder positioning finger by turning the bobbin case holder until the finger recess is at the top. Place the projection on the finger into the bobbin case holder recess and tighten the finger attaching screws securely, allowing $\frac{1}{32}$ inch clearance between the outside edge of projection and inside edge of bobbin case recess (Fig. 15).

Tip the machine back so that it rests on the rest pin in the table top. Insert a new needle. Loosen the two screws and swing out the bobbin case positioning finger (B, Fig. 14). Loosen the three set screws (A) in the hook and hold the hook and bobbin case holder in such a position as to prevent interference with the needle. Turn the handwheel in operating direction until the needle bar is at its lowest position, continue to turn the handwheel until the needle is ascending and the lowest timing mark of the pair used (C, Fig. 13) in setting the needle bar is even with the lower edge of the needle bar bushing (B).

Turn the hook on the shaft until the point of the hook is even with the center of the needle and as close to the needle as possible without deflecting it. A spacing of .003 to .005 inch between the needle and the point of the hook is satisfactory. With the hook in this position,

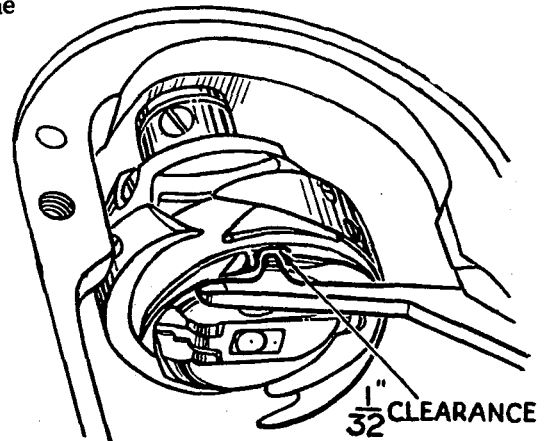

Fig. 15

HOOK LUBRICATION

Insert the bobbin case in the hook and run the machine. **CAUTION!** Do not run the machine without the bobbin case in the hook, as hook damage may result. After a minute of running, place a piece of white paper directly below the hook, continue running the machine, check the delivery of oil from the hook. The hook is properly lubricated when a definite pattern of oil appears on the test paper after a five second run.

Running through the middle of the hook shaft is an oil metering insert pin which controls the flow of oil to the hook. An occasional cleaning of this insert pin will insure its proper operation.

To withdraw the pin from the hook shaft, the hook must first be removed. The end of the insert pin has an internal thread into which Union Special metering pin extractor No. 21227 AZ may be screwed and the pin withdrawn.

The metering insert pin should fit snugly in the hook shaft. If it is loose it should be withdrawn and kinked slightly.

When re-assembling the hook it must be re-timed as previously instructed.

HOOK SHAFT

Should it become necessary to replace the hook shaft, drain the oil from the gear case and remove gear case cover and hook. Loosen gear set screws (A, Fig. 16) and carefully withdraw hook shaft. Remove thrust collar from left end of hook shaft by loosening screws (B). To re-assemble, slide collar onto the hook shaft with faced end adjacent to bushing (C) and insert hook shaft as far as it will go. Tighten set screws (A) making sure that one of the set screws bears against the flat on the shaft. Check for bind. Then set the thrust collar against bushing (C), tighten screws (B) and check for bind.

If, when the hook shaft is removed, the gear (D), the thrust washers (E) and the oil seal washer (F) should drop into the gear case they will have to be re-assembled as shown in the sketch. Clean, dry, and re-seal gasket and housing cover using gasket cement. Fill gear case with proper oil.

Re-time the hook as previously described.

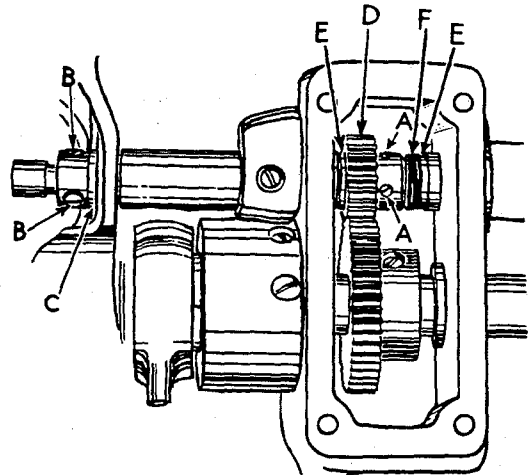

Fig. 16

FEED DOG HEIGHT

In regulating the height of the feed dog, it should be at its highest position and the presser foot resting directly against it.

The feed dog holder attaching screw (A, Fig. 17) should be loosened slightly, and regulating screw (B) should be turned either clockwise to raise the feed dog or counterclockwise to lower it. Make sure that the bottom of the shank of the feed dog holder rests against the head of regulating screw.

A suggested initial setting is as follows: Feed dogs having 22 or more teeth per inch should show about 3/64 inch above the throat plate at highest point of travel, those having 16 or less teeth per inch should show the depth of a full tooth above the throat plate. The feed dog can be tilted up or down as required by loosening screws (A and C).

Loosen feed dog holding screws (D) to space the feed dog, front to back or sideways in throat plate.

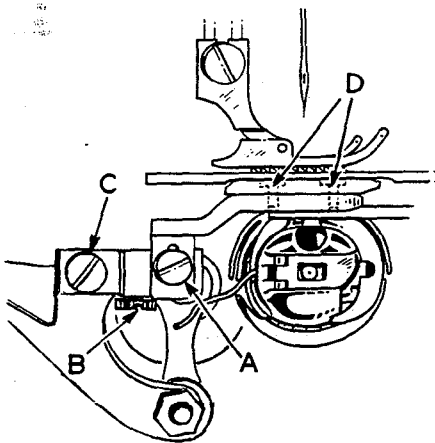

Fig. 17

PRESSER BAR CONNECTION

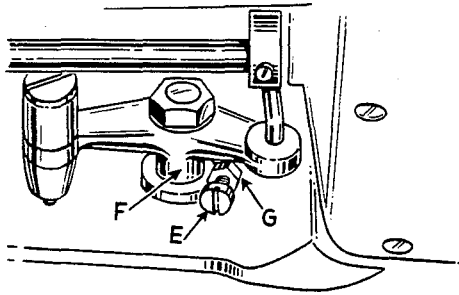

Fig. 18

The presser bar connection (A, Fig. 19) should be set so that it bears against the hand lifter (B) at all times.

This is accomplished by turning the machine over on its side, loosening lock nut (G, Fig. 18) and relocating the stop screw (E) on the lifter lever bell crank (F). By turning the stop screw counterclockwise, the presser bar connection is brought closer to the hand lifter. While turning the screw, move the hand lifter up and down continuously until no free motion can be felt. Tighten lock nut (G) to lock screw in position.

PRESSER BAR GUIDE

When locating the presser bar guide (C) Fig. 19) the presser foot must rest directly against the throat plate with the feed dog in its lowest position.

The guide is properly set when there is a 1/16 inch space between presser bar guide and the connection.

To obtain this setting, loosen set screw (D) in the guide and insert screw driver between the connection and the guide. Tap on presser foot to insure its being down on the throat plate, center the foot by turning it so that needle enters the middle of its slot and re-tighten screw (D) in guide.

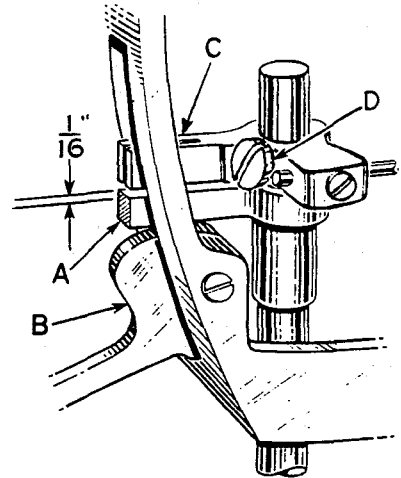

Fig. 19

THREAD CONTROL

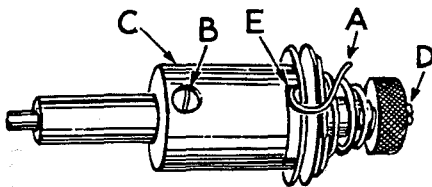

Fig. 20

Test check spring tension (A, Fig. 20). There should be enough tension to insure a good returning snap when spring is depressed and released. Should it require adjusting, loosen set screw in the head on right side of tension post (G, Fig. 21) and remove tension post assembly. Partially loosen tension post set screw (B, Fig. 20) in tension post socket (C). Holding the socket in the left hand turn the tension post (D) counterclockwise with the right hand until the check spring moves away from the upper stop (E) and has no tension

on it. Turn the tension post (D) in a clockwise direction until the spring again touches the upper stop (E). Then proceed further in the same direction until the desired tension is obtained. When correctly set, the tension post set screw (B) should be drawn up snugly but not forcefully. Further adjustment of the check spring tension can be made by inserting a screw driver into the slotted end of the tension post (D) and turning in the required direction.

Replace tension assembly with the check spring about 1/2 inch above the thread take-up wire. While the tension post assembly is being replaced, the presser foot should be resting on the throat plate.

The frame take-up eyelet (A, Fig. 22) should be set at its lowest position.

For the final setting of check spring, sew slowly on a piece of material and observe the action of the check spring. The thread from the check spring to the take-up thread wire should be taut when the take-up is at the bottom of its stroke.

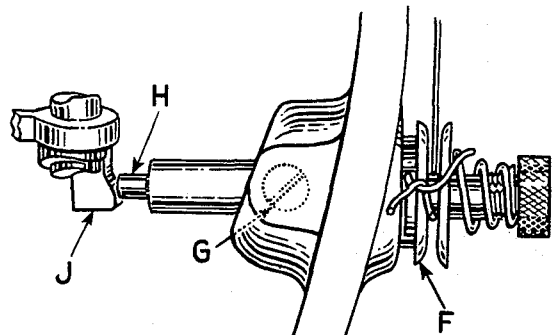

Fig. 21

LOCATING TENSION RELEASE MECHANISM

The tension assembly should be located in bed from front to back, so that when the presser foot is raised to its highest position, the tension discs (F, Fig. 21) are opened just enough to allow the thread to pass through the discs freely.

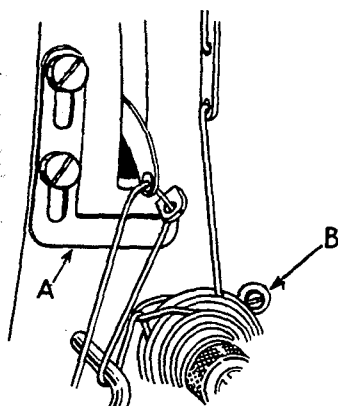

Fig. 22

To position the tension assembly, see that set screw in bed (G, Fig. 21) is loose and tension assembly adjusting screw (B, Fig. 22) is screwed down to the bed.

Lift the presser foot hand lifter to its highest position; with the left hand grasp the thread and pull it through the tensions, with the right hand push tension post deeper into the machine until release pin (H, Fig. 21) pressing against the presser bar connection (J) has opened the tension discs just enough to allow the thread to pull through freely. Re-tighten set screw (G), turn tension assembly adjusting screw (B, Fig. 22) counterclockwise until it contacts the flange of the tension post socket.

NOTE: When tacking is required, the tension assembly should be adjusted so that the pressure foot may be raised to clear the heaviest seam without releasing the needle thread tension.

STITCH REGULATING PLUNGER LOCK

To lock the stitch regulating plunger at any desired stitch length tilt the machine back against rest pin and tighten screw (F, Fig. 24) securely.

FEED TIMING

The definite relationship which exists between the feed dog and the needle bar motions is referred to as timing.

To check for the proper setting of the feed timing, proceed as follows:

1. Set the stitch length midway between long and short as described in "To Change The Stitch Length."
2. Check to see that the feed dog is set at its proper height as described in "Feed Dog Height" (Fig. 17).
3. Turn the handwheel in the operating direction until the top of the needle eye is even with the top surface of the throat plate.
4. For Styles 61400 A, 61400 E, 61400 F, 61400 G, 61400 H, 61400 N, 61400 P, top of the feed dog teeth should be level with the upper surface of throat plate.
- 4A. For Styles 61400 B, 61400 R, 61400 S, top of the feed dog teeth should be about .010 inch above the upper surface of the throat plate. An advanced or fast timing is one in which the top of the feed dog teeth have sunk below the surface of the throat plate, before the top of the descending needle eye has reached the surface of the throat plate. Conversely, a retarded or slow feed timing is one in which the top of the feed dog teeth are still above the surface of the throat plate when the top of the descending needle eye has reached the surface of the throat plate. A simple method of advancing or retarding the feed timing slightly to meet the varying conditions in material and operations is provided in the head of the machine.

CAUTION! A change in the feed timing always requires an additional change in the setting of the sewing hook.

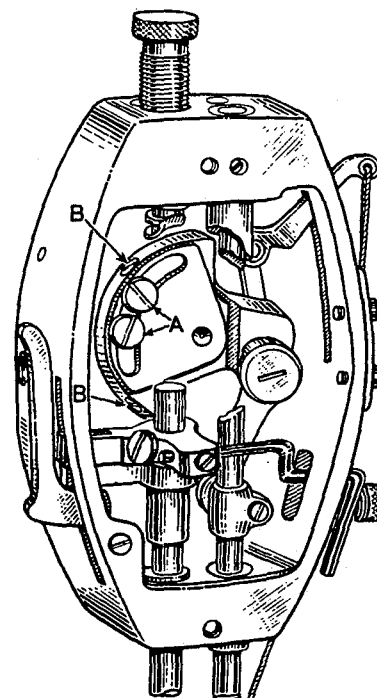

Fig. 23

MECHANIC'S INSTRUCTIONS (Continued)

FEED TIMING (Continued)

To change the setting of the feed timing proceed as follows:

1. Remove needle as a safety precaution.
2. Loosen the two screws (A, Fig. 23) holding the counterweight to the segment plate, and the two screws (B) holding the counterweight to main shaft.
3. Hold handwheel and turn the counterweight in a clockwise direction to retard the feed and a counterclockwise direction to advance the feed. The two screws (A) holding the counterweight to the segment plate will be moved toward either end of segment plate slot, depending on whether the feed timing was advanced or retarded.
4. Re-tighten all screws securely. It is very important that the counterweight should not be allowed to slip.

MACHINE TIMING

If at any time the feed driving gears should have to be removed, the machine will have to be re-timed by the following procedure:

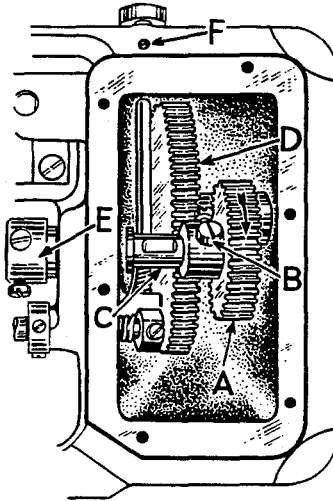

Fig. 24

1. Lay machine on its side on the bench.
2. Remove the large gear housing cover. Note caution should be observed that machine is tilted far enough back so oil will not leak out. Also be careful in removing the housing cover that the gasket is not mutilated.
3. Loosen screws (B, Fig. 24) and slide gear (A) to the extreme right so it is out of mesh with the idler gear (D).
4. Looking through the stitch length indicator window on the top of the bed plate, rotate the lower main shaft (C) in the operating direction until the timing mark "-0-" appears between the pointers of the indicator window. Then rotate upper main shaft in the operating direction until the needle bar reaches its highest position. Carefully turn gear (A), without disturbing the lower main shaft setting, until the set screw lies directly above the flat in the lower main shaft. The gears should then be engaged as closely as possible in this position. While holding the gear and thrust collar (E) tightly between thumb and forefinger tighten set screw against flat in shaft securely, then tighten the second set screw and check to see that there is no end play in the shaft and that the machine revolves freely.
5. Clean, dry and re-seal gasket and housing cover using gasket cement.
6. Replace housing cover. Check position of oil distributing plate as previously described under "Lubrication."
7. Re-set sewing hook.

**MECHANIC'S INSTRUCTIONS
FOR
TOP ROLLER FEED MACHINES
STYLES 61400 N, 61400 P, 61400 R, 61400 S**

All adjustments for the top roller feed machines are the same as for the plain feed Lockstitch machines, except for the timing and setting of the top roller feed.

CAUTION! At no time should the machine be run or turned over by hand with the two feeds in direct contact with one another as chipped teeth may result.

Synchronization of the top roller feed with the lower feed is of the utmost importance. The top roller should begin feeding at the same time that the feed dog begins its feeding cycle and should continue feeding until the feed dog has completed its feeding cycle.

The top roller feed has been synchronized with the lower feed at the factory. However, if at any time, any parts of the mechanism involved have to be replaced, observing the following steps will simplify the synchronization and setting of the top roller feed:

1. The top feed roller on Styles 61400 N and 61400 R, which are equipped with the roller to the right of the needle bar, should be set as close to the presser foot as possible without contacting. Loosen screw (A, Fig. 25) which holds the shank of the roller. Lift the presser foot off the throat plate by means of the hand lifter and move the top roller. Re-tighten screw. On Styles 61400 P and 61400 S, which have the feed roller behind the needle bar, set the roller so that its slot is directly in line with the needle.

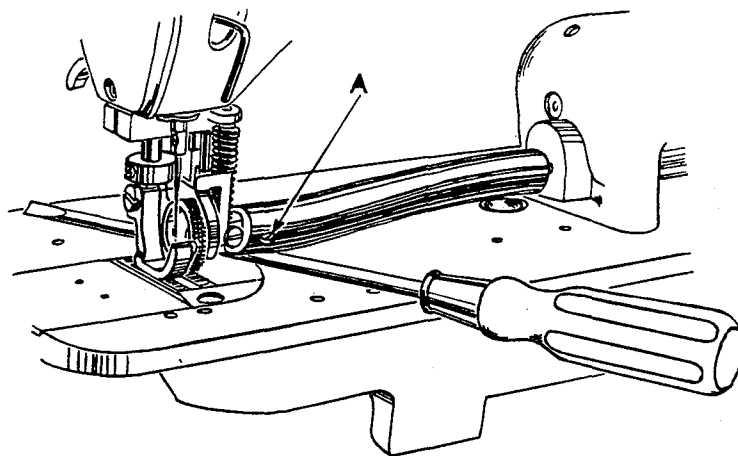

Fig. 25

2. Set the stitch length of the main feed as previously described at its longest travel so that the letter "L" is visible in the indicator window in bed plate.
3. Lay the machine on its side and set the stitch length of the top roller feed at its longest travel so that the pointer (A, Fig. 26) is at the letter "L" on the indicator (B). To accomplish this, depress the lever (C) and while holding it down, turn the handwheel in operating direction until the point of the lever is felt to drop into the slot (D) in the adjustable eccentric. Still holding the lever down, continue turning the handwheel until it can be turned no further. If at this point, the pointer (A) is not as the letter "L", loosen the two screws (E) in the hub of the indicator and turn the indicator on the shaft so that the letter "L" is at the pointer. Tighten screws.
4. Now check the synchronization of the top feed roller and the main feed. Raise the top roller off the bed plate by means of the hand lifter lever, turn handwheel in operating direction and observe the top roller and main feed dog. They should begin feeding at the same time. To synchronize the two feeds, lay the machine on its side and loosen the time screw (F, Fig. 26) in the adjustable eccentric. The time screw can be easily identified by the words "time spot" stamped on the right side of the eccentric. Now loosen set screw (G). If the top feed roller began feeding before the main feed dog, turn the eccentric (H) in the opposite direction from the operating direction of the main shaft. The operating direction of the main shaft is indicated by arrow (Fig. 26). Only a slight movement of the eccentric is necessary to change the time at which the top roller commences to feed. Tighten the two screws (F and G) and check synchronization. When tightening the two screws do not force the eccentric against the clutch driving arm as a bind may be created. If the main feed dog began feeding before the top feed roller, proceed as above except turn the eccentric in the same direction as the operating direction of the main shaft.
5. Changing the position of the top feed eccentric on the shaft will affect the location of the top feed stitch length indicator (B, Fig. 26) and it will now have to be re-set so that pointer stops at the letter "L" as described in paragraph 3 above.

**MECHANIC'S INSTRUCTIONS
FOR
TOP ROLLER FEED MACHINES
STYLES 61400 N, 61400 P, 61400 R, 61400 S
(Continued)**

6. Set the main feed to produce the required length of stitch in the same manner as previously described. When checking the length of stitch produced by the main feed place a screw driver or similar object under the top feed shaft and raise the feed roller (Fig. 25) so that the actual stitch length of the main feed can be observed.

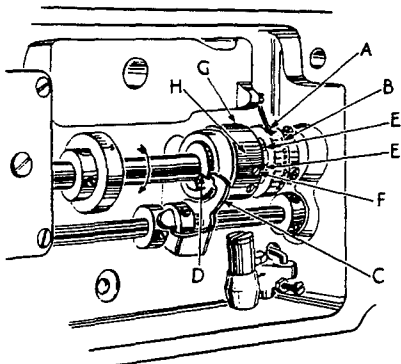

Fig. 26

7. Now set the stitch length of the top roller feed so that with two plies of material under the presser foot, both plies feed uniformly and straight and that neither ply feeds faster than the other. The top roller feed stitch length is set in the same manner as described in paragraph 3, except that in shortening the stitch, the handwheel is turned opposite to the operating direction. The letters on the graduations of the main feed and top roller feed stitch length indicators have no relationship to one another, so that with both indicators set at the same letters, the stitch lengths of both feeds will not necessarily be the same.

USEFUL SUGGESTIONS

If the machine fails to work satisfactorily, though apparently in good repair, it is possible that some minor trouble exists. For this reason delay may be avoided by acting on the following:

1. See that the needle is set properly; that it is the recommended needle; that it is straight and free from nicks and rough places; that it is inserted in the needle bar as far up as it will go; and that there is clearance all around needle as it enters the throat plate.
2. See that the machine is threaded correctly and the needle thread is delivered to the machine properly.
3. See that the proper tension is applied to the threads.
4. See that the presser foot is set so that the needle does not strike it.
5. See that the feed dog is not striking the hook or throat plate.
6. Take off throat plate and remove accumulated lint from feed dog slots and hook.
7. See that there are no nicks or cuts in the wall of the throat plate needle hole. String out this hole with fine emery cord or cloth.
8. See that the take-up spring acts freely, is not grooved or nicked. Remove any gummy oil and dirt around tension discs.
9. See that the hook thread deflector is free from nicks and burrs.
10. See that the point of the hook is not blunted, broken or nicked.
11. See that the hook is timed correctly.
12. See that the feed is timed correctly.
13. See that bobbin case holder finger is set 1/32 inch from bobbin case holder, which is the correct position for passing the thread.
14. See that all screws are tight.

ORDERING REPAIR PARTS

ILLUSTRATIONS

This catalog has been so arranged as to simplify the ordering of repair parts. Exploded views of the various sections of the mechanism are shown so that the parts may be seen in their actual position in the machine. On the page opposite the illustration will be found the listing of the parts with their part number, description and the number of pieces required in the particular view being shown.

The numbers in the first column are reference numbers only and indicate the position of the part in the illustration. The reference number should never be used in ordering parts. Always use the part number shown in the second column.

Those component parts of sub-assemblies which can be furnished for repairs are indicated by the fact that their descriptions are indented under the descriptions of the main sub-assembly. Example:

12	61434	Feed Bar -----	1
13	89	Screw -----	1
14	88 D	Screw -----	1
15	61439 A	Feed Dog Holder Support -----	1

In those cases where the parts for the various styles in Class 61400 are not the same the difference will be shown in the illustrations and descriptions. When a part is used in all machines covered by this catalog no machine style will be mentioned.

Following the pages of exploded views will be found several pages of illustrations of throat plates, feed dogs, presser feet, attachments, and miscellaneous parts. Since it would be impossible to show all these parts in the exploded views, they have been arranged so that the throat plates and feed dogs that can be used together are grouped on the pages of illustrations, and presser feet and attachments have been arranged, as closely as possible, according to similarity in design and use. On the descriptive pages covering these parts, no reference numbers or number of pieces required are given.

At the back of the book will be found a numerical index of all the parts shown in this book, which will facilitate locating the illustration when only the part number is known.

IDENTIFYING PARTS

Where the construction permits, each part is stamped with its part number. Some of the smaller parts are stamped with an identification letter to distinguish them from parts similar in appearance.

All part numbers represent the same part, regardless of the catalog in which they appear.

USE GENUINE NEEDLES AND REPAIR PARTS

Success in the operation of these machines can be secured only with genuine Union Special Needles and Repair Parts as furnished by the Union Special Machine Company, its subsidiaries and authorized distributors. They are designed according to the most approved scientific principles, and are made with utmost precision. Maximum efficiency and durability are assured.

Genuine needles are packaged with labels marked *Union Special*. Genuine repair parts are stamped with the Union Special trademark. Each trademark is your guarantee of the highest quality in materials and workmanship.

TERMS

Prices are strictly net cash and subject to change without notice. All shipments are forwarded f. o. b. shipping point. Parcel Post shipments are insured unless otherwise directed. A charge is made to cover the postage and insurance.

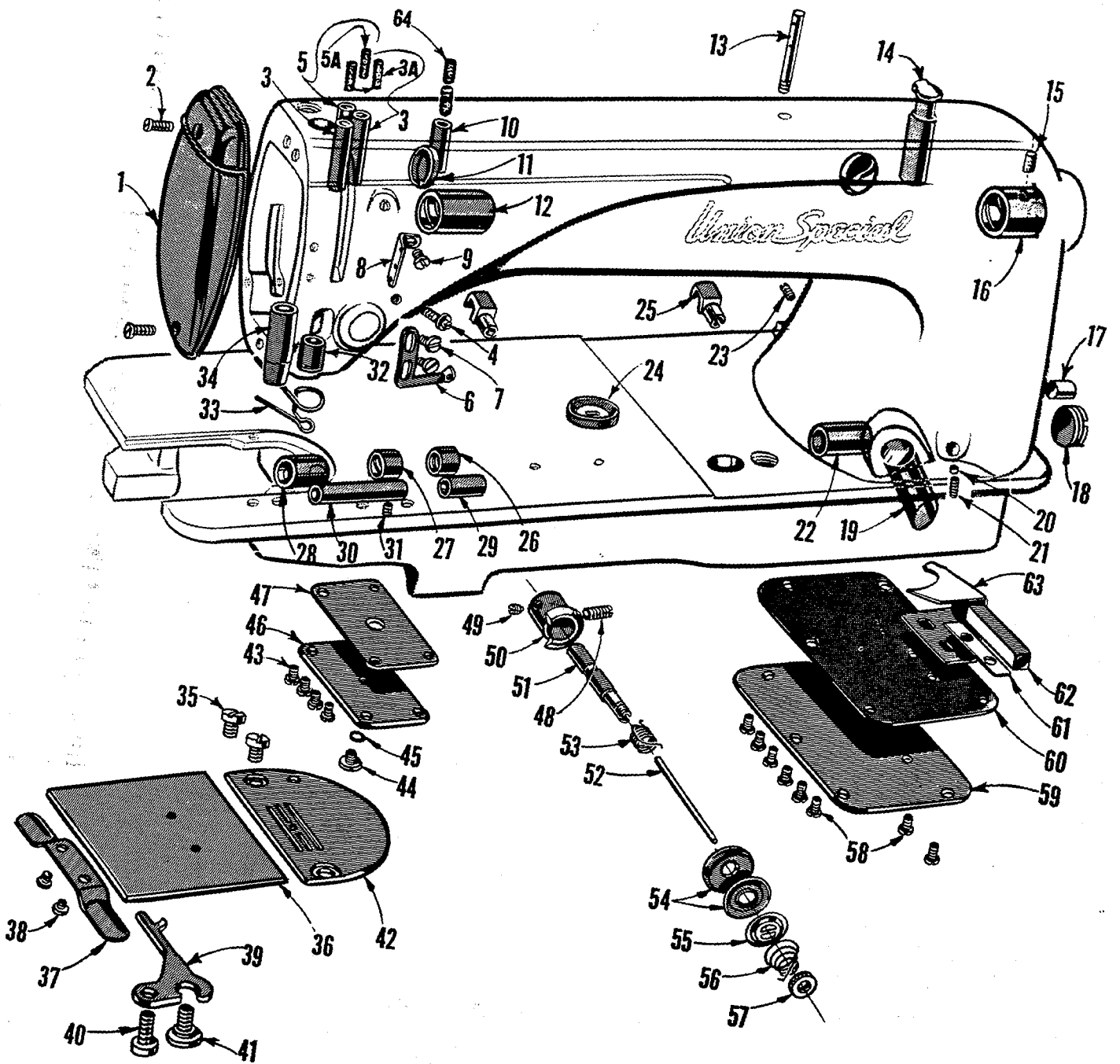

MAIN FRAME, MISCELLANEOUS BUSHINGS, COVERS AND PLATES

Ref. No.	Part No.	Description	Amt. Req.
1	B61382 H	Head Cover -----	1
2	22569 B	Screw -----	2
3	61293	Oil Tube -----	2
3A	666-126	Oil Wick, for No. 61293 -----	2
4	22863 B	Tension Assembly Adjusting Screw -----	1
5	61393 C	Oil Tube, for all Styles except 61400 N, P-----	1
	61393 E	Oil Tube, for Styles 61400 N, P-----	1
5A	666-127	Oil Wick, for No. 61393 C-----	1
6	61351 J	Thread Eyelet-----	1
7	22585 A	Screw -----	2
8	61271	Thread Eyelet-----	1
9	22570 A	Screw -----	1
10	61393 B	Oil Tube -----	1
11	61293 N	Plug, for inside of arm-----	2
12	61490 A	Main Shaft Bushing, left-----	1
13	61272	Needle Thread Guide Pin-----	1
14	61394 AE	Oil Cup -----	1
15	666-104	Oil Wick-----	1
16	61490	Main Shaft Bushing, right-----	1
17	50-558 Blk.	Plug-----	1
18	22539 D	Plug Screw-----	1
19	50-568 Blk.	Oil Sight Gauge-----	1
20	61245 G	Stitch Regulator Thumb Screw Locking Insert-----	1
21	22597 A	Screw -----	1
22	61432 B	Feed Driving Shaft Bushing, right-----	1
23	22597 A	Screw -----	1
24	61449 H	Stitch Regulator Indicator Window-----	1
25	61375	Hinge Stud-----	2
26	61432 D	Feed Driving Shaft Oil Retaining Bushing, right-----	1
27	61432 E	Feed Driving Shaft Oil Retaining Bushing, left-----	1
28	61432 C	Feed Driving Shaft Bushing, left-----	1
29	61341 D	Hook Shaft Bushing, right-----	1
30	61341 C	Hook Shaft Bushing, left-----	1
31	96 A	Screw -----	1
32	61454	Needle Bar Bushing, lower-----	1
33	61470	Needle Thread Guide, for Styles 61400 A, B, E, F, G, H, J, AA, BA-----	1
	61470 B	Frame Thread Guide, for Styles 61400 N, P, R, S-----	1
34	61457 C	Presser Bar Bushing, lower, for Styles 61400 A, B, E, F, G, H, J, AA, BA-----	1
35	376	Screw -----	2
36	61202	Bed Slide-----	1
37	61273	Bed Slide Spring-----	1
38	91 A	Screw -----	2
39	61414 A	Bobbin Case Holder Positioning Finger-----	1
40	93	Screw -----	1
41	22742	Screw -----	1
42		Throat Plate, see pages of Throat Plates and Feed Dogs-----	1
43	22570 A	Screw -----	4
44	22730	Plug Screw-----	1
45	660-257	Gasket-----	1
46	61282 A	Cover, for hook shaft gear case-----	1
47	61282 E	Gasket-----	1
48	22597 E	Set Screw-----	1
49	89	Set Screw-----	1
50	61492 A	Tension Post Socket-----	1
51	61492	Tension Post-----	1
52	61292 G	Tension Release Pin-----	1
53	61453	Take-up Spring-----	1
54	109	Tension Disc-----	2
55	61292 H	Tension Release Washer-----	1
56	61392 F-9	Tension Spring, for Styles 61400 A, E, F, G, H, J, N, P, AA-----	1
	61392 F-14	Tension Spring, for Styles 61400 B, R, S, BA-----	1
57	61292 C	Tension Nut-----	1
58	22570 A	Screw -----	8
59	61382 J	Cover, for feed driving shaft gear case-----	1
60	61282 D	Gasket-----	1
61	61394 R	Gasket-----	1
62	61394 Q	Oil Distributing Plate Retaining Block-----	1
63	61394 P	Oil Distributing Plate-----	1
64	666-20	Oil Wick-----	2

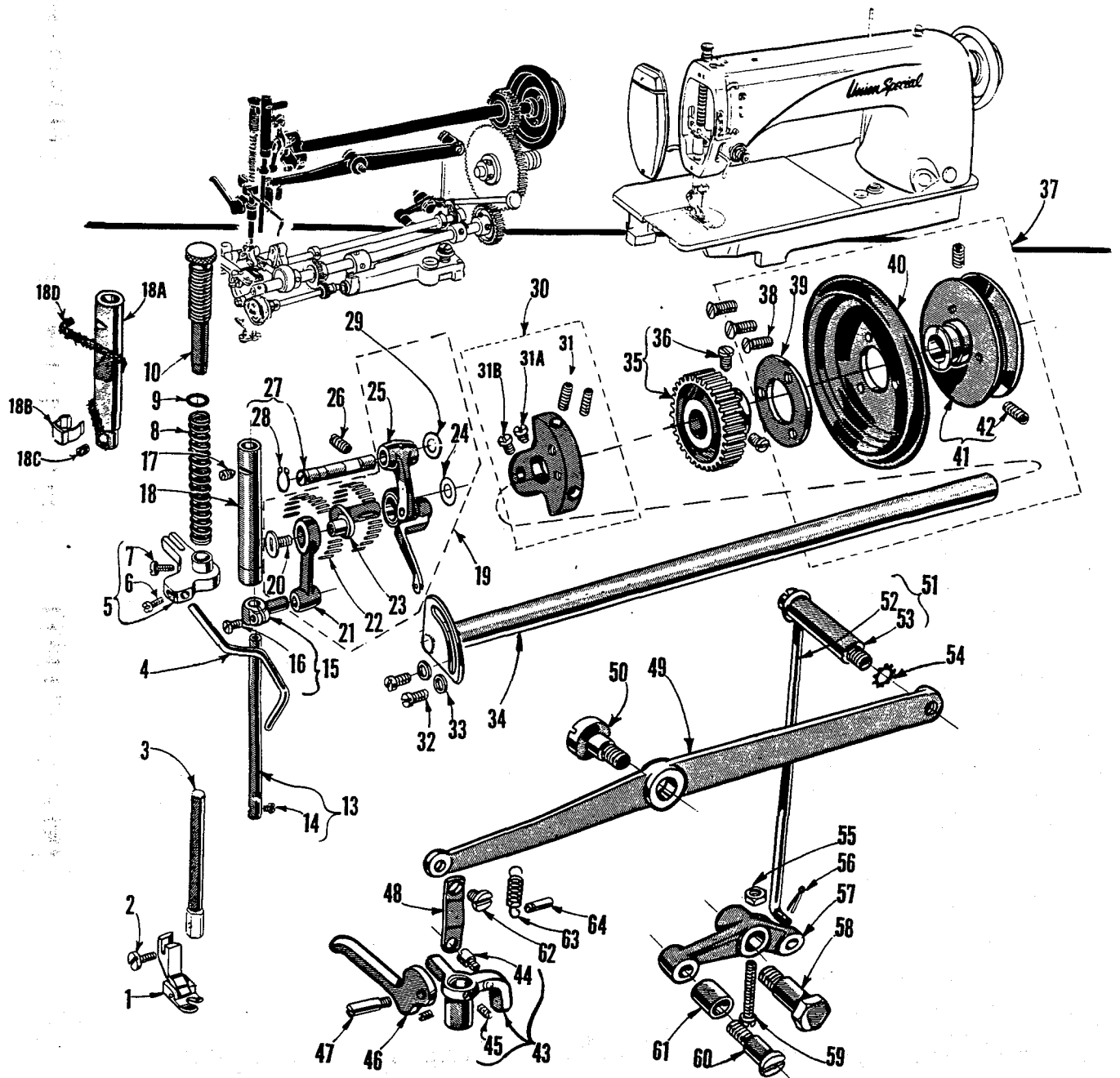

UPPER SHAFT, PRESSER BAR, NEEDLE BAR, AND FOOT LIFTER MECHANISM

Ref. No.	Part No.	Description	Amt. Req.
1		Presser Foot, see pages of Presser Feet -----	1
2	22775	Screw -----	1
3	61457	Presser Bar, for Styles 61400 A, B, E, F, G, H, J, AA, BA -----	1
4	61453 B	Take-up Spring Thread Wire -----	1
5	61459 B	Presser Bar Guide, for Styles 61400 N, P, R, S -----	1
	61459 A	Presser Bar Guide, for Styles 61400 A, B, E, F, G, H, J, AA, BA -----	1
6	77	Screw -----	1
7	22596 D	Screw, for No. 61459 B -----	1
	93 A	Screw, for No. 61459 A -----	1
8	61256	Presser Spring, for Styles 61400 A, E, F, G, H, J, N, P, R, S, AA -----	1
	61356	Presser Spring, for Styles 61400 B, BA -----	1
9	61256 G	Washer -----	1
10	61457 B	Presser Spring Regulator -----	1
13	61417	Needle Bar, for Styles 61400 A, B, E, F, G, H, J, AA, BA -----	1
14	22768 A	Needle Set Screw -----	1
15	61255	Needle Bar Connection -----	1
16	22562 B	Screw -----	1
17	96	Screw -----	1
18	61454 D	Needle Bar Bushing, upper, for all Styles except 61400 N, P -----	1
18A	61454 A	Needle Bar Bushing, upper, for Styles 61400 N, P -----	1
18B	61454 B	Spring Clip, for Styles 61400 N, P -----	1
18C	666-186	Oil Felt, for Styles 61400 N, P -----	1
18D	CL21	Oil Wick, for 61393 E, Styles 61400 N, P -----	1
19	29486 B	Take-up Lever and Needle Bar Link Assembly -----	1
20	22757 C	Screw -----	1
21	61255 H	Needle Bar Link -----	1
22	61351 K-625	Needle Bearings, .0625 inch diameter -----	38
	61351 K-626	Needle Bearings, .0626 inch diameter -----	38
	61351 K-627	Needle Bearings, .0627 inch diameter -----	38
23	61252 J	Crank Pin -----	1
24	61351 C	Thrust Washer -----	1
25	61351 Q	Take-up Lever Assembly -----	1
26	22597 A	Screw -----	1
27	61251 D	Take-up Lever Pin -----	1
28	660-205	Retaining Ring -----	1
29	61451 C	Thrust Washer, for take-up lever ----- if required	
30	61391 C	Main Shaft Counterweight, for Styles 61400 A, E, F, G, H, J, N, P, AA -----	1
	61391 D	Main Shaft Counterweight, for Styles 61400 B, R, S, BA -----	1
31	22894 V	Screw -----	2
31A	22880	Spot Screw -----	1
31B	22570 B	Set Screw -----	1
32	22596 D	Screw -----	2
33	8372 A	Washer -----	2
34	61322 B	Main Shaft -----	1
35	61360	Main Shaft Driving Gear -----	1
36	22884	Screw -----	2
37	61421	Handwheel Assembly, for No. 1 "V" or Round Belt -----	1
38	22574	Screw -----	3
39	61321 L	Hub Washer -----	1
40	61321 J	Handwheel -----	1
41	61421 A	Pulley Hub -----	1
42	22894 AB	Screw -----	2
43	61458	Presser Bar Connection, for Styles 61400 A, B, E, F, G, H, J, AA, BA -----	1
	61458 A	Presser Bar Connection, for Styles 61400 N, P, R, S -----	1
44	22892	Screw -----	1
45	22560 B	Screw, for No. 61458 A on Styles 61400 N, P, R, S -----	2
46	61265	Hand Lifter -----	1
47	22799 M	Screw Pin -----	1
48	61267	Lifter Lever Link -----	1
49	61466 A	Lifter Lever -----	1
50	22890	Screw, left thread -----	1
51	61368 A	Lifter Lever Extension Stud and Connecting Rod, complete -----	1
52	61368	Lifter Lever Connecting Rod -----	1
53	61366 C	Lifter Lever Extension Stud -----	1
54	652 B-20	Lock Washer -----	1
55	9937	Nut -----	1
56	660-142	Cotter Pin -----	1
57	61468	Lifter Lever Bell Crank, for Styles 61400 A, B, E, F, G, H, J, AA, BA -----	1
	61368 E	Lifter Lever Bell Crank, for Styles 61400 N, P, R, S -----	1
58	22817 A	Stud -----	1
59	22874 F	Screw -----	1
60	22712 F	Screw -----	1
61	61368 F	Roller -----	1
62	22758 B	Screw -----	1
63	15872 F	Spring -----	1
64	61267 G	Spring Pin -----	1

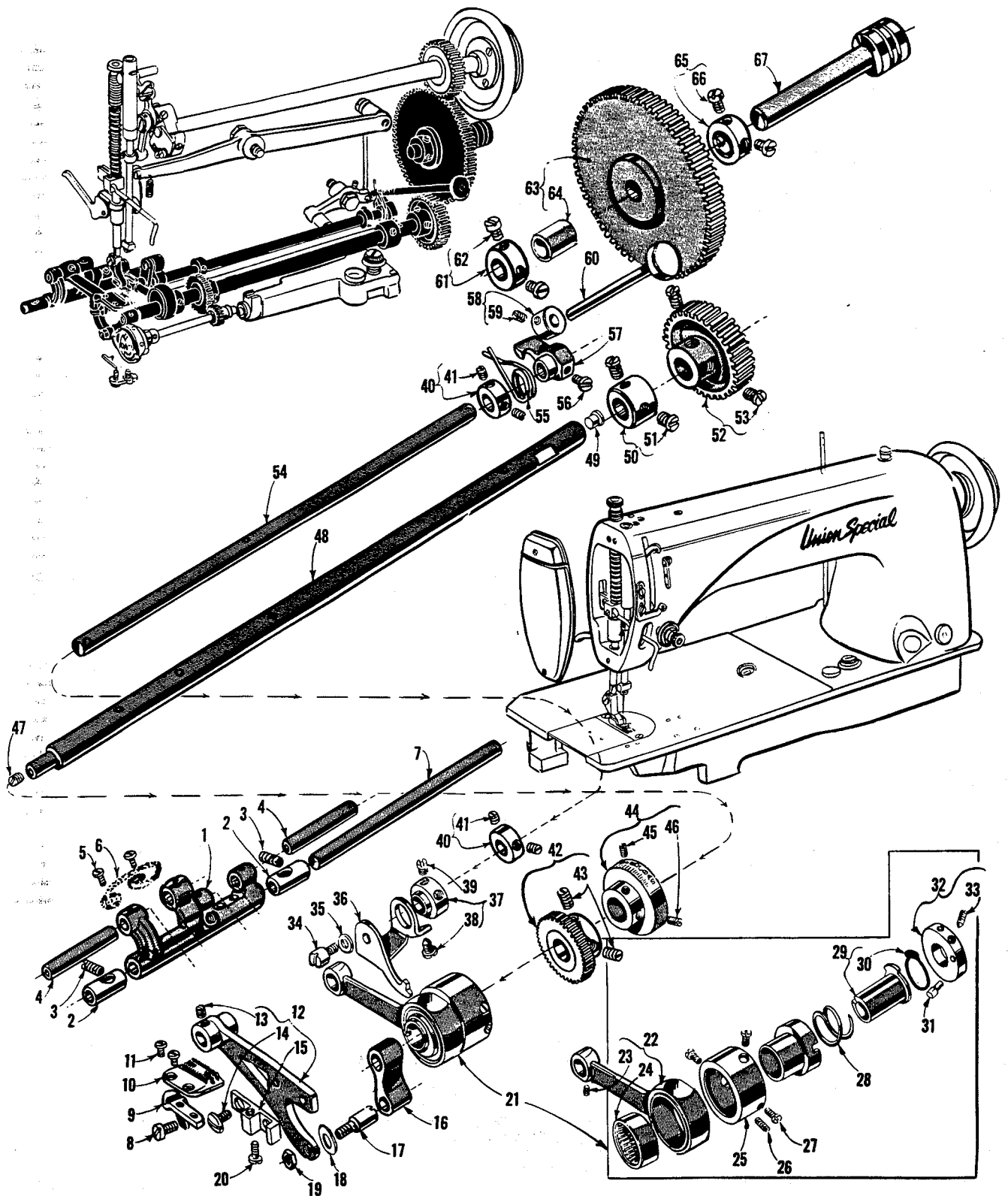

FEED DRIVING AND STITCH REGULATING MECHANISM

<u>Ref. No.</u>	<u>Part No.</u>	<u>Description</u>	<u>Amt. Req.</u>
1	61236	Feed Rocker-----	1
2	61336 U	Bushing-----	2
3	22894 E	Screw-----	2
4	61235	Feed Bar and Feed Rocker Connection Link Shaft-----	2
5	90	Screw-----	2
6	61336 Y	Feed Rocker Oil Wick-----	1
7	61236 G	Feed Rocker Shaft-----	1
8	22528	Screw-----	1
9	61439	Feed Dog Holder-----	1
10		Feed Dog, see pages of Feed Dogs and Throat Plates-----	1
11	22768	Screw-----	2
12	61434	Feed Bar-----	1
13	89	Screw-----	1
14	88 D	Screw-----	1
15	61439 A	Feed Dog Holder Support-----	1
16	61233 N	Feed Link-----	1
17	22845 D	Feed Lift Link Stud-----	1
18	61434 G	Washer-----	1
19	15037 A	Nut-----	1
20	22775 A	Screw-----	1
21	29126 BS	Feed Drive Eccentric Assembly-----	1
22	61438 A	Connection Rod-----	1
23	88	Screw-----	1
24	660-225	Needle Bearing-----	1
25	61437 C	Feed Driving Eccentric Retaining Housing-----	1
26	719	Screw-----	1
27	22564 B	Screw-----	3
28	61449 B	Stitch Regulating Thrust Spring-----	1
29	61449	Stitch Regulating Eccentric-----	1
30	61449 A	Stitch Regulating Eccentric Friction Disc-----	1
31	61437 B	Feed Driving Eccentric Pivot Pin-----	1
32	61437 A	Feed Driving Eccentric Timing Collar-----	1
33	22764 B	Time Spot Screw-----	1
34	22802 A	Screw-----	1
35	51242 M	Washer-----	1
36	61449 F	Stitch Regulating Pawl-----	1
37	61449 E	Stitch Regulating Pawl Collar-----	1
38	22880	Screw-----	1
39	22845 G	Screw-----	1
40	61248 H	Stitch Regulating Shaft Collar-----	2
41	531	Screw-----	2
42	61443	Hook Shaft Driving Gear-----	1
43	22894 J	Set Screw-----	2
44	61449 G	Stitch Length Indicator-----	1
45	95	Set Screw-----	1
46	96	Time Spot Screw-----	1
47	22743	Plug Screw-----	1
48	61432 A	Feed Driving Shaft-----	1
49	50-552 Blk.	Plug-----	1
50	61360 G	Feed Driving Shaft Collar-----	1
51	22884	Screw-----	2
52	61260 A	Feed Driving Shaft Gear-----	1
53	22884	Screw-----	2
54	61348 A	Stitch Regulator Shaft-----	1
55	61447	Stitch Regulator Plunger Spring-----	1
56	93 A	Screw-----	1
57	61246 A	Stitch Regulator Plunger Lever-----	1
58	161	Collar-----	1
59	88	Screw-----	1
60	61445	Stitch Regulator Plunger-----	1
61	61264 A	Intermediate Gear Shaft Collar, left-----	1
62	HA61 D	Screw-----	2
63	61261 A	Feed Driving Intermediate Gear-----	1
64	61263	Bushing-----	1
65	61264	Intermediate Gear Shaft Collar, right-----	1
66	HA61 D	Screw-----	2
67	62262	Intermediate Gear Shaft-----	1

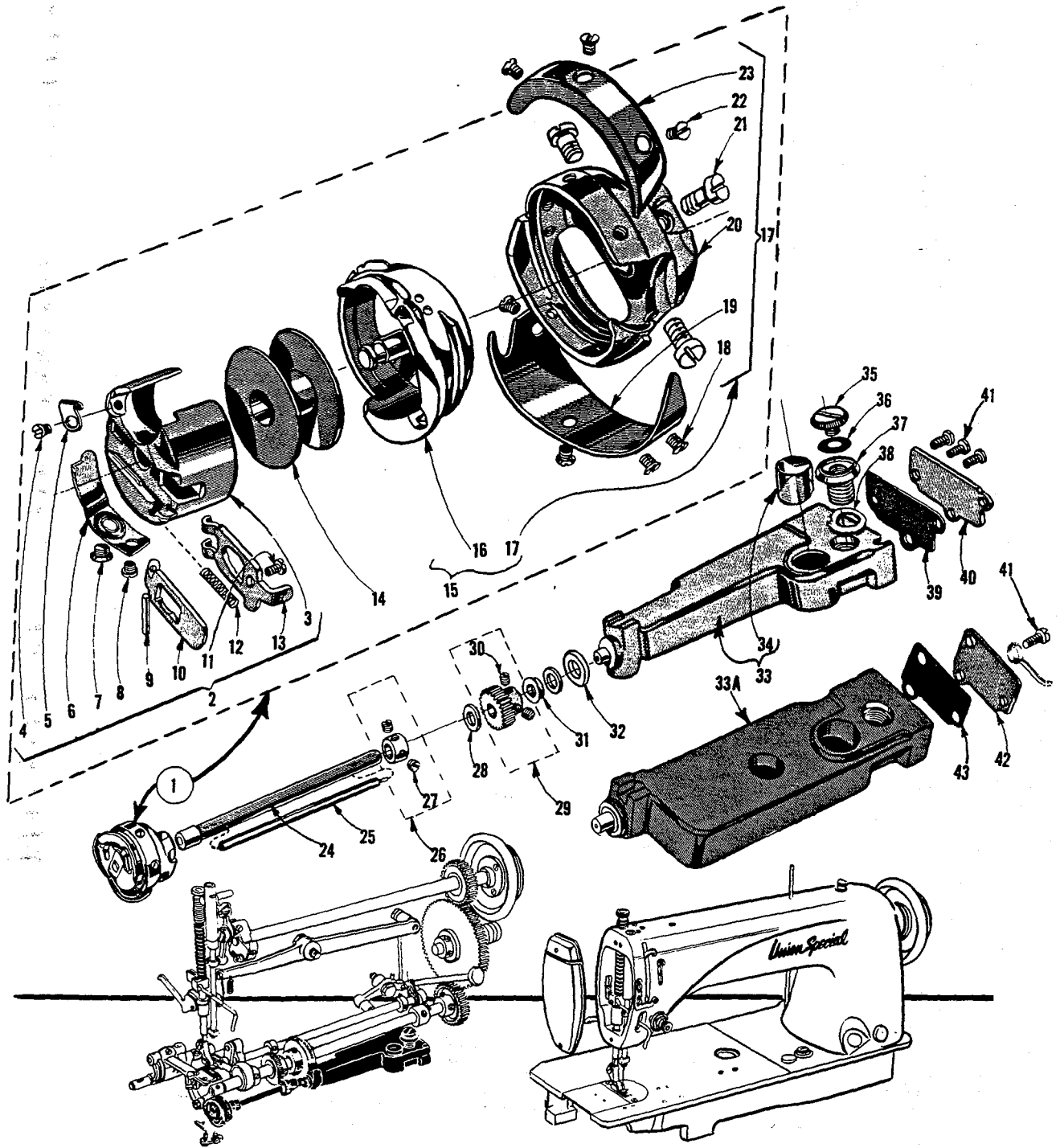

ROTARY HOOK AND LUBRICATING MECHANISM

<u>Ref. No.</u>	<u>Part No.</u>	<u>Description</u>	<u>Amt. Req.</u>
1	29474 G	Rotating Hook Assembly, for 30-3 and smaller thread -----	1
	L628	Rotating Hook Assembly, for sizes 16-4 to 30-4 thread -----	1
2	61413 E	Bobbin Case Assembly-----	1
3	61413 F	Bobbin Case -----	1
4	22564 F	Screw-----	1
5	61413 G	Eyelet -----	1
6	61414 C	Bobbin Case Tension Spring -----	1
7	22716 B	Tension Regulating Screw -----	1
8	22564 E	Screw-----	1
9	61216	Bobbin Case Latch Hinge Pin-----	1
10	61415 A	Bobbin Case Latch Lever -----	1
11	22564 E	Stop Screw -----	1
12	61216 N	Bobbin Case Latch Spring-----	1
13	61415	Bobbin Case Latch -----	1
14	61212	Bobbin-----	1
15	61407 B	Hook, Thread Retainer, Thread Deflector and Bobbin Case Holder Assembly, for 30-3 and smaller thread-----	1
16	61414	Bobbin Case Holder, for 30-3 and smaller thread-----	1
	L629	Bobbin Case Holder, for sizes 16-4 to 30-4 thread-----	1
17	61407 C	Hook, Thread Retainer and Thread Deflector Assembly -----	1
18	22716 A	Screw-----	4
19	61210 B	Hook Thread Deflector-----	1
20	61208 B	Hook -----	1
21	22569 H	Screw-----	3
22	22716 H	Screw-----	3
23	61411 A	Hook Thread Retainer -----	1
24	61340 C	Hook Shaft-----	1
25	61396 F	Hook Shaft Oil Metering Insert-----	1
26	61242	Hook Shaft Collar -----	1
27	88	Screw-----	2
28	61341 J	Thrust Washer-----	2
29	61244	Hook Shaft Pinion Gear -----	1
30	89	Screw-----	2
31	61341 G	Hook Shaft Oil Seal Washer-----	1
32	61394 AF	Gasket -----	2
33	61394 AJ	Hook Oil Reservoir, for Styles 61400 A, B, E, F, G, H, J, AA, BA -----	1
33A	61494	Hook Oil Reservoir, for Styles 61400 N, P, R, S-----	1
34	50-567 Blk.	Oil Sight Gauge -----	1
35	61394 AC	Filler Hole Plug Screw -----	1
36	61394 M	Gasket -----	1
37	61394 L	Oil Reservoir Securing Screw -----	1
38	61494 U	Washer -----	1
39	61394 AA	Gasket, for Styles 61400 A, B, E, F, G, H, J, AA, BA--	1
40	61394 Z	Oil Reservoir End Cover, for Styles 61400 A, B, E, F, G, H, J, AA, BA-----	1
41	22569 C	Screw, for Styles 61400 A, B, E, F, G, H, J, AA, BA---	3
	22569 C	Screw, for Styles 61400 N, P, R, S-----	3
42	61494 A	Oil Reservoir End Cover, for Styles 61400 N, P, R, S	1
43	61494 B	Gasket, for Styles 61400 N, P, R, S-----	1

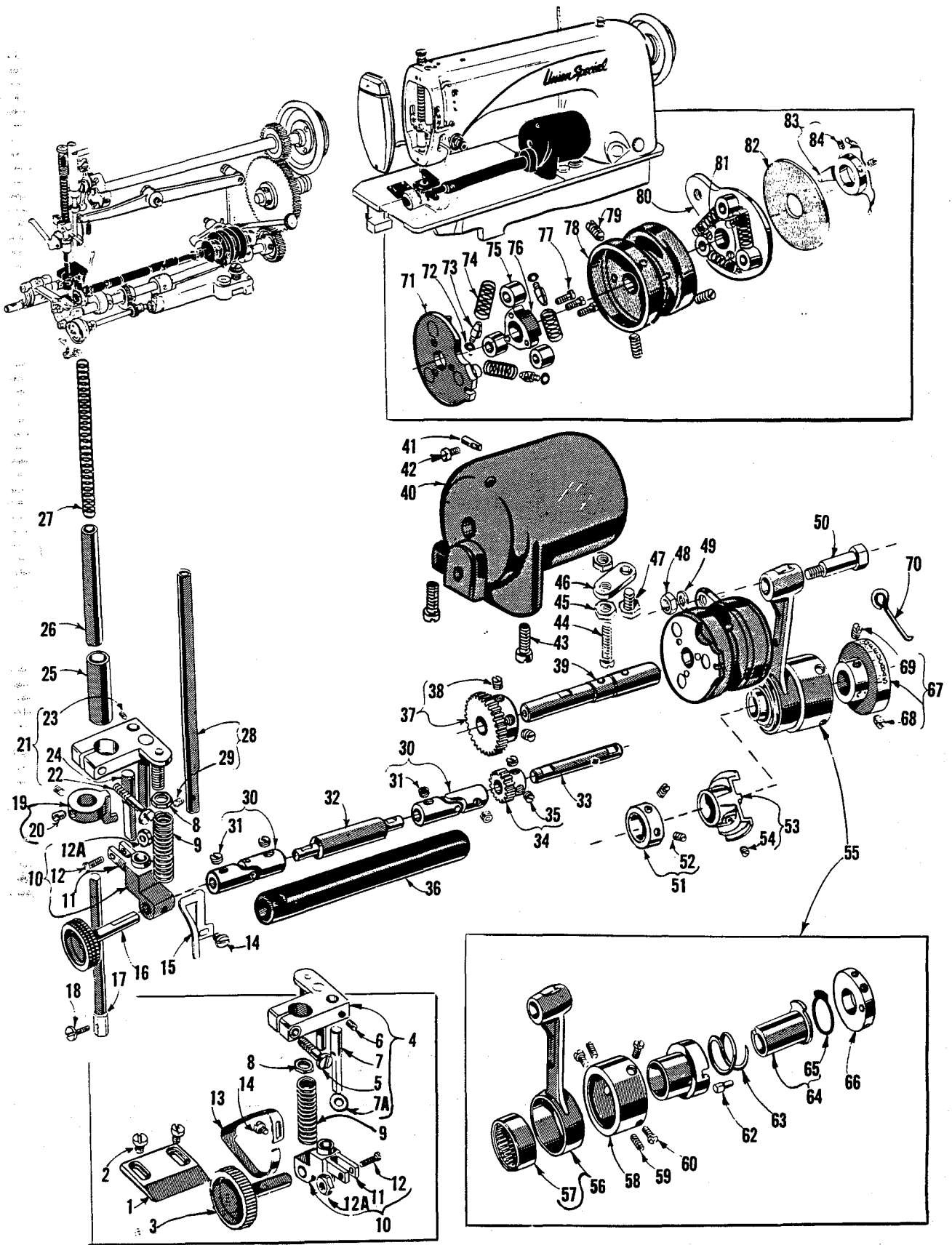

PARTS FOR TOP ROLLER FEED MACHINE STYLES 61400 N, 61400 P, 61400 R, 61400 S

Ref. No.	Part No.	Description	Amnt. Req.
1	61439 P	Supplementary Cloth Plate Section, for Styles 61400 P, S	1
2	376	Screw, for Styles 61400 P, S	2
3	61439 T	Feed Roller, for Styles 61400 P, S	1
4	61439 M	Feed Roller Mounting Bracket, for Styles 61400 P, S	1
5	22874	Screw	1
6	88	Screw	1
7	50-799 Blk.	Roller Feed Guide	1
7A	53678 N	Washer	1
8	12987 A	Nut	1
9	61439 AV	Spring	1
10	51239 AA	Feed Roller Block	1
11	51239 AB	Bushing	1
12	22747 B	Screw	1
12A	43443 Q	Nut	1
13	61439 R	Stripper, for Styles 61400 P, S	1
14	22704	Screw	1
15	51239 AE	Feed Roller Guard, for Styles 61400 N, R	1
16		Feed Roller, see page of Feed Rollers	1
17	61457 F	Presser Bar	1
18	22775	Screw	1
19	61439 K	Feed Roller Lifter Connection	1
20	22560 B	Screw	2
21	51239 AC	Feed Roller Mounting Bracket, for Styles 61400 N, R	1
22	22874	Screw	1
23	88	Screw	1
24	50-799 Blk.	Roller Feed Guide	1
25	61457 G	Presser Bar Bushing	1
26	61457 E	Presser Bar Plunger	1
27	61256	Presser Spring	1
28	61417 C	Needle Bar	1
29	28 C	Screw	1
30	51239 G	Universal Joint	2
31	22894 T	Screw	2
32	61339 F	Feed Roller Driving Shaft, left section	1
33	61339 E	Feed Roller Driving Shaft, right section	1
34	51239 E	Feed Roller Driving Shaft Gear	1
35	22580	Screw	2
36	61339 H	Feed Roller Shaft Guard	1
37	61339 D	Feed Roller Driving Gear	1
38	95	Set Screw	2
39	51239 S	Clutch Shaft	1
40	61439 G	Clutch Housing	1
41	51239 B	Pin	1
42	22729	Screw	1
43	22891	Screw	2
44	22874	Supporting Screw	1
45	9937	Nut	2
46	61439 F	Adjusting Plate	1
47	22882	Screw	1
48	18	Nut	1
49	21657 E	Washer	1
50	22832 G	Screw	1
51	2339 F	Thrust Washer	1
52	98	Screw	2
53	61449 AA	Stitch Regulating Collar	1
54	89	Screw	1
55	29126 DG	Roller Feed Driving Eccentric Assembly	1
56	61439 AJ	Connection Rod	1
57	660-226	Needle Bearing	1
58	61437 C	Eccentric Housing	1
59	22560 A	Set Screw	2
60	22564 B	Screw	3
62	61437 U	Pivot Pin	1
63	61449 B	Spring	1
64	61149 G	Stitch Regulating Eccentric, .078 inch throw	1
65	61149 H	Stitch Regulating Eccentric Friction Disc	1
66	61437 A	Eccentric Timing Collar	1
67	61149	Stitch Length Indicator	1
68	96	Time Spot Screw	1
69	95	Set Screw	1
70	61449 L	Stitch Indicator	1
71	61339 S	Clutch Check Plate	1
72	41358 T	Washer	6
73	41358 S	Spring Support Pin	6
74	41358 Q	Spring	6
75	41258	Clutch Roller	6
76	41358 P	Clutch Block, left	1
77	22747	Screw	6
78	41358 M	Clutch Barrel	1
79	22597 B	Screw	3
80	61439 H	Clutch Lever	1
81	41358 N	Clutch Block, right	1
82	51239 U	Clutch Brake Washer	1
83	51239 T	Clutch Brake	1
84	22565 C	Screw	2

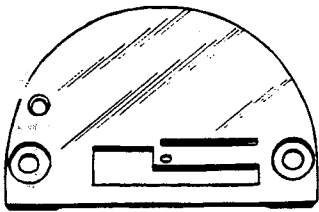

L28



L29

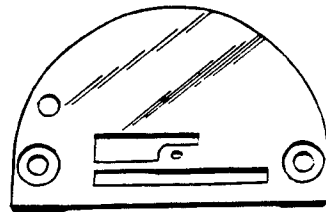

L287

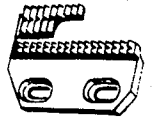

61305 G

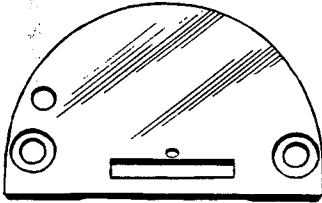

L54

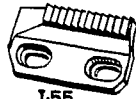

L55

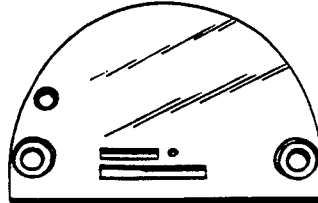

L391



L569

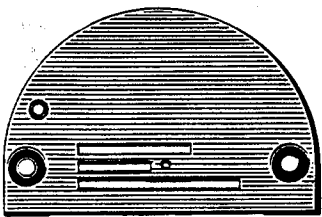

61224

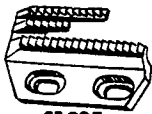

61205

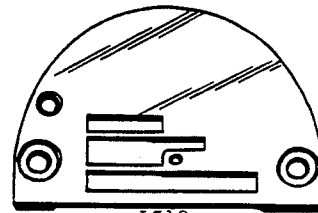

L519

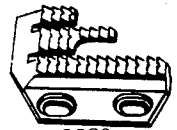

L520

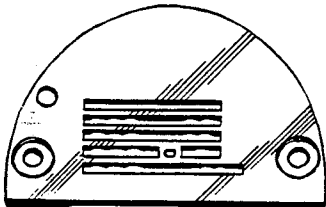

L118

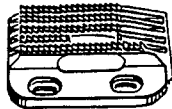

L119

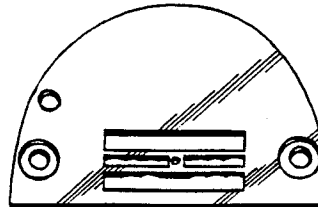

L580

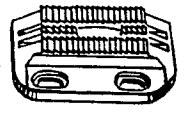

L579

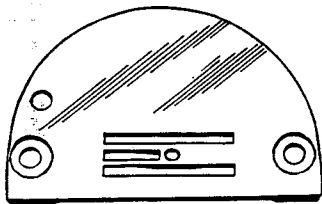

L143

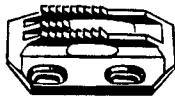

L206

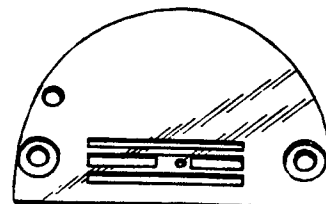

61424 Y-063

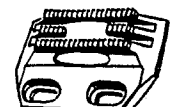

61405 Y

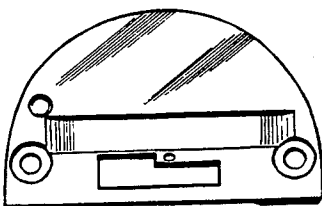

L223

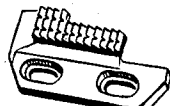

L223

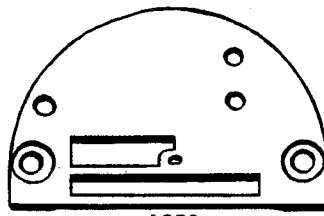

L936

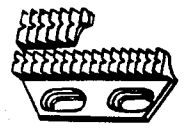

61405 V

THROAT PLATE AND FEED DOG COMBINATIONS
FOR STYLES 61400 A

<u>Part No.</u>	<u>Description</u>
L28	With .063 inch needle hole, for miscellaneous hemming operations; feed dog No. L29, presser foot No. L30 (.085 inch thick)
L29	Teeth cut 16 per inch, for miscellaneous hemming operations; throat plate No. L28, presser foot No. L30
L54	With .063 inch needle hole, for miscellaneous seaming on leather; feed dog No. L55, presser foot No. 61420 BA (.085 inch thick)
L55	Teeth cut 16 per inch, for miscellaneous seaming on leather; throat plate No. L54, presser foot No. 61420 BA
L118	With .063 inch needle hole, for edge stitching shirts and dresses; feed dog No. L119, presser foot No. 61420 AM (.085 inch thick)
L119	Teeth cut 22 per inch, for miscellaneous edge stitching with 1/2 inch margin; throat plate No. L118, presser foot No. 61420 AM
L143	With .093 inch needle hole, for miscellaneous hemming operations, used with 3/16 inch plate hemmer; feed dog No. L206, presser foot No. L205 (.085 inch thick)
L206	Teeth cut 16 per inch, for miscellaneous hemming operations, used with 3/16 inch plate hemmer; throat plate No. L143, presser foot No. L205
L222	With .063 inch needle hole, for top stitching collars of dress shirts; feed dog No. L223, presser foot No. L768 (.085 inch thick)
L223	Teeth cut 16 per inch, for top stitching collars of dress shirts; throat plate No. L222, presser foot No. L768
L287	With .063 inch needle hole, for edge stitching coats and vests; feed dog No. 61305 G, presser foot No. 61320 (.085 inch thick)
L369	Teeth cut 22 per inch, for hemming handkerchiefs; throat plate No. L391, presser foot No. 61320 AJ
L391	With .063 inch needle hole, for hemming handkerchiefs; feed dog No. L369, presser foot No. 61320 AJ (.085 inch thick)
L519	With .073 inch needle hole, for edge stitching sack coats and similar operations; feed dog No. L520, presser foot No. L518 (.085 inch thick)
L520	Teeth cut 14 per inch, for edge stitching sack coats; throat plate No. L519, presser foot No. L518
L579	Teeth cut 22 per inch, for edge stitching pockets; throat plate No. L580, presser foot No. 61220 W
L580	With .063 inch needle hole, for edge stitching pockets and similar operations; feed dog No. L579, presser foot No. 61220 W (.085 inch thick)
L936	With .063 inch needle hole, for quilting operation; feed dog No. 61405 V, presser foot No. L298 (.085 inch thick)
61205	Teeth cut 16 per inch, for setting pockets on shirts and miscellaneous operations on house dresses; throat plate No. 61224-063, presser feet Nos. 61220 J, 62320 AH
61224-063	With .063 inch needle hole, for seaming house dresses; also in size .093 inch needle hole for setting pockets in work and dress pants; feed dog No. 61205, presser feet Nos. 61220 J, 61320 AH (.085 inch thick)
61305 G	Teeth cut 16 per inch, for edge stitching coats and vests; throat plates Nos. L287, 61324 F-093, presser feet Nos. 61320, L290
61405 V	Teeth cut 12 per inch, for quilting operations; throat plate No. L936, presser foot No. L298
61405 Y	Teeth cut 22 per inch, for hemming shirts; throat plate No. 61424 Y-063, presser foot No. 61220 J
61424 Y-063	With .063 inch needle hole, for hemming shirts; also in size .073 inch needle hole; feed dog No. 61405 Y, presser foot No. 61220 J (.085 inch thick)

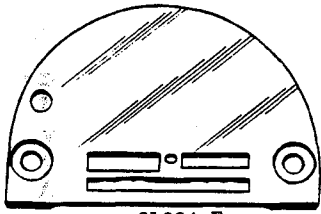

61224 E

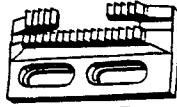

61205 E

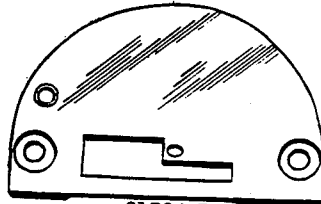

61324 P

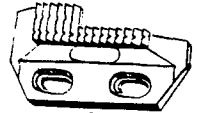

61305 P

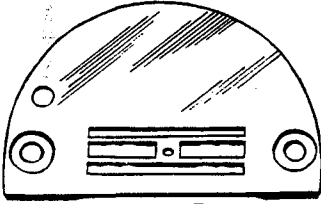

61224 F

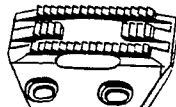

61205 D

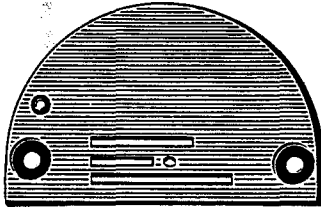

61324

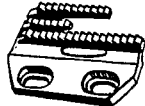

61305

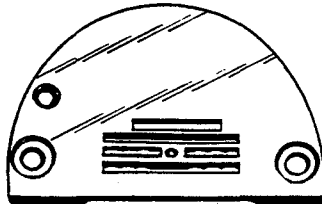

61424 J

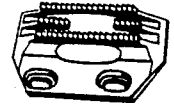

61405 J

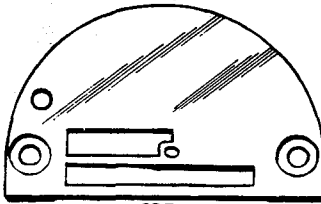

61324E

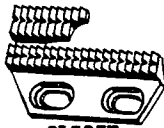

61305E

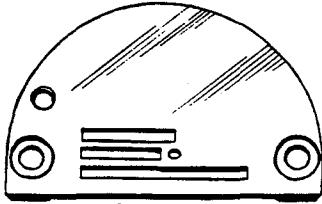

61424 L

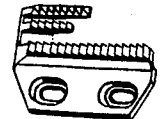

61405 L

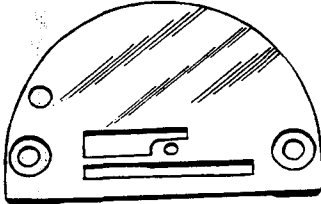

61324 F



61305 G

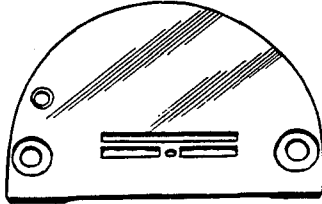

61424 M

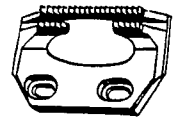

61405 M

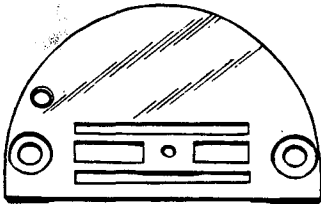

61324 L

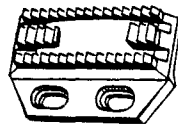

61305 M

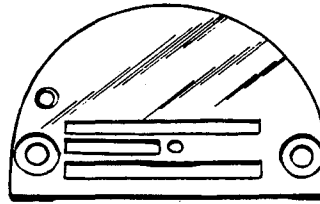

61424 P

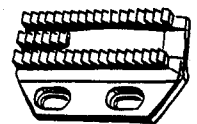

61405 P

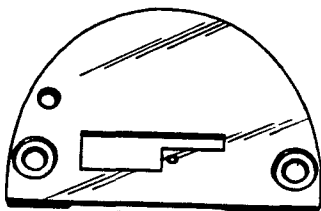

61424 R

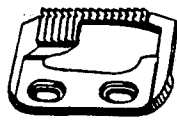

61405 R

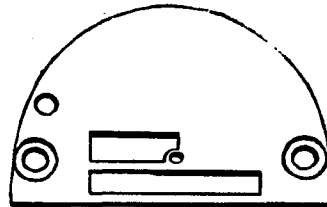

61424 U



61405 U

THROAT PLATE AND FEED DOG COMBINATIONS
FOR STYLE 61400 A

<u>Part No.</u>	<u>Description</u>
61205 D	Teeth cut 16 per inch, for setting pockets on shirts; throat plate No. 61224 F-073, presser feet Nos. 61320 AH, 61320 AJ
61205 E	Teeth cut 16 per inch, for hemming work shirts; throat plate No. 61224 E-063, presser foot No. 61420 BN
61224 E-063	With .063 inch needle hole, for hemming work shirts; feed dog No. 61205 E, presser foot No. 61420 BN (.085 inch thick)
61224 F-063	With .063 inch needle hole, for setting pockets of dress shirts; also in sizes .083, .093 inch needle holes for work shirts; feed dog No. 61205 D, presser feet Nos. 61320 AH, 61320 AJ (.085 inch thick)
61305	Teeth cut 16 per inch, for miscellaneous operations on cotton and wool trousers; throat plate No. 61324-093, presser foot No. 61320 B
61305 E	Teeth cut 16 per inch, for miscellaneous operations on coats and pants; throat plate No. 61324 E-073, presser foot No. L266
61305 G	Teeth cut 16 per inch, for edge stitching coats and vests; throat plate No. L287 or 61324 F-093, presser foot No. 61320 or L290
61305 M	Teeth cut 12 per inch, for seaming heavy coats and trousers; throat plate No. 61324 L-093, presser foot No. 61320 S
61305 P	Teeth cut 16 per inch, for edge stitching zipper tabs; throat plate No. 61324 P-093, presser foot No. 61420 BE
61324-063	With .063 inch needle hole, for miscellaneous operations on cotton and wool trousers; also in sizes .073, .093 inch needle holes; feed dog No. 61305, presser foot No. 61320 B (.085 inch thick)
61324 E-063	With .063 inch needle hole, for miscellaneous operations on coats and pants; also in sizes .073, .093 inch needle holes; feed dog No. 61305 E, presser foot No. L266 (.085 inch thick)
61324 F-063	With .063 inch needle hole, for edge stitching coats and similar garments; also in size .093 inch needle hole; feed dog No. 61305 G, presser foot No. L290 (.085 inch thick)
61324 L-093	With .093 inch needle hole, for seaming heavy coats, trousers and similar operations; feed dog No. 61305 M, presser foot No. 61320 S (.085 inch thick)
61324 P-093	With .093 inch needle hole, for edge stitching zipper tabs and similar operations; feed dog No. 61305 P, presser foot No. 61420 BE (.085 inch thick)
61405 J	Teeth cut 22 per inch, for top stitching shirt collars; throat plate No. 61424 J-063, presser foot No. 61420 AH
61405 L	Teeth cut 16 per inch, for binding rayon material; throat plate No. 61424 L-063, presser foot No. 61420 BE
61405 M	Teeth cut 22 per inch, for attaching yokes to shirts; throat plate No. 61424 M-063, presser foot No. 61420 BD
61405 P	Teeth cut 14 per inch, for hemming high back overall suspenders; throat plate No. 61424 P-093, presser foot No. 61320 C
61405 R	Teeth cut 16 per inch, for sewing zipper tabs to pants flies; throat plate No. 61424 R-073, presser foot No. 61420 V
61405 U	Teeth cut 16 per inch, for miscellaneous seaming on medium weight materials; throat plate No. 61424 U-093, presser foot No. 61220 P
61424 J-063	With .063 inch needle hole, for top stitching shirt collars; feed dog No. 61405 J, presser foot No. 61420 AH (.085 inch thick)
61424 L-063	With .063 inch needle hole, for binding rayon; feed dog No. 61405 L, presser foot No. 61420 BE (.085 inch thick)
61424 M-063	With .063 inch needle hole, for attaching yokes to shirts; feed dog No. 61405 M, presser foot No. 61420 BD (.085 inch thick)
61424 P-093	With .093 inch needle hole, for hemming high back overall suspenders; feed dog No. 61405 P, presser foot No. 61320 C (.085 inch)
61424 R-073	With .073 inch needle hole, for sewing zipper tabs to pants flies; feed dog No. 61405 R, presser foot No. 61420 V (.085 inch thick)
61424 U-093	With .093 inch needle hole, for general seaming medium weight work; feed dog No. 61405 U, presser foot No. 61220 P (.085 inch thick)

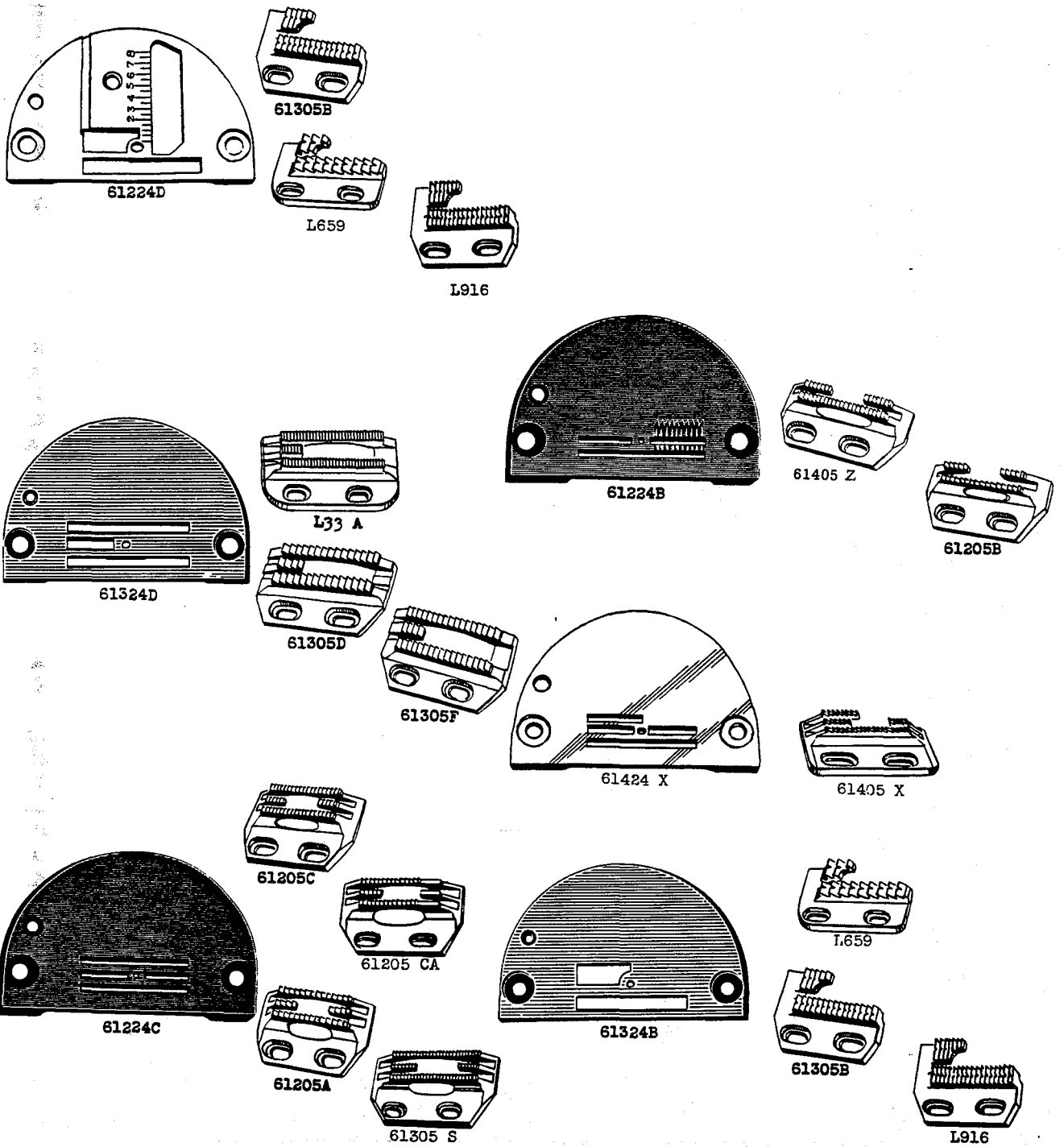

THROAT PLATE AND FEED DOG COMBINATIONS
FOR STYLE 61400 A

<u>Part No.</u>	<u>Description</u>
L33 A	Teeth cut 32 per inch, for tacking flies to overalls; throat plate No. 61324 D-063, presser foot No. 61320 Q
L659	Teeth cut 10 per inch, for binding on melton and similar operations; throat plates Nos. 61224 D-073, 61324 B-093, presser feet Nos. 61220 H, 61320
L916	Teeth cut 22 per inch, for sewing bias strips on dresses and similar material; throat plates Nos. 61224 D-063, 61324 D-063, presser foot No. 61220 H
61205 A	Teeth cut 16 per inch, for plain seaming on work shirts, dress and semi-dress pants; throat plate No. 61224 C-073, presser feet Nos. 61220 J, 61320 AB
61205 B	Teeth cut 16 per inch, for hemming work shirts, dresses and similar garments; throat plate No. 61224 B-063, presser feet Nos. 61220 B, 61220 C
61205 C	Teeth cut 22 per inch, for plain seaming on dress shirts, blouses, dresses and other light material; throat plates Nos. 61224 C-043, 61224 C-063, presser foot No. 61220 J
61205 CA	Teeth cut 22 per inch, for hemming shirts, using hemmer No. L96, throat plate No. 61224 C-073, presser foot No. 61220 J
61224 B-063	With .063 inch needle hole, for hemming house dresses; also in size .093 inch needle hole for work shirts; feed dogs Nos. 61205 B, 61405 Z, presser feet Nos. 61220 B, 61220 C (.085 inch thick)
61224 C-063	With .063 inch needle holes for seaming dresses; also in sizes .043, .073, .083 inch needle holes for seaming work shirts and dress pants; feed dogs Nos. 61205 A, 61205 C, 61205 CA, 61305 S, presser feet Nos. 61220 C, 61220 J, 61320 AB (.085 inch thick)
61224 D-063	With .063 inch needle hole, for binding operations, used with English type binder; also in size .073 inch needle hole; feed dog Nos. 61305 B, L659, L916, presser feet Nos. 61220 H, 61320 (.085 inch thick)
61305 B	Teeth cut 16 per inch, for edge stitching on suit coats and vests; throat plate No. 61324 B-063, presser foot No. 61320
61305 D	Teeth cut 14 per inch, for miscellaneous seaming operations; throat plate No. 61324 D-093, presser foot No. 61320 AA
61305 F	Teeth cut 16 per inch, for miscellaneous operations on light weight material; throat plate No. 61324 D-073, presser foot No. 61320 AA
61305 S	Teeth cut 32 per inch, for hemming work shirts; throat plates Nos. 61224 C-043, 61224 C-073, presser feet Nos. 61220 C, 61420 BB
61324 B-063	With .063 inch needle hole, for edge stitching on suits, coats and vests; also in sizes .073, .083, .093 inch needle holes; feed dogs Nos. 61305 B, L659, L916, presser foot No. 61320 (.085 inch thick)
61324 D-063	With .063 inch needle hole, for tacking flies to overalls and similar operations; also in sizes .073, .083, .093 inch needle holes; feed dogs Nos. L33 A, 61305 D, 61305 F, presser foot No. 61320 Q (.085 inch thick)
61405 X	Teeth cut 22 per inch, for hemming on rayon; throat plate No. 61424 X-063, presser foot No. 61420 X
61405 Z	Teeth cut 22 per inch, for edge stitching pockets on dresses, shirts and similar garments; throat plate No. 61224 B-063, presser foot No. 61420 AJ
61424 X-063	With .063 inch needle hole, for hemming rayon material; feed dog No. 61405 X, presser foot No. 61420 X (.085 inch thick)

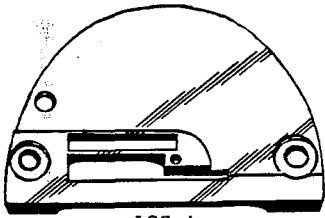

L83 A

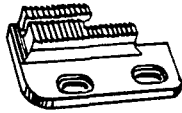

61305 U

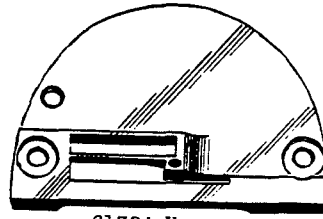

61324 U

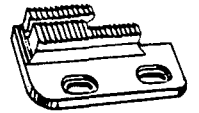

61305 U

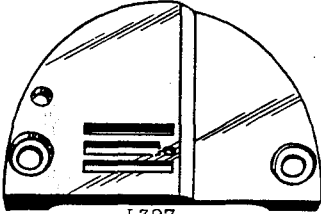

L397

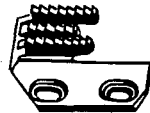

L398

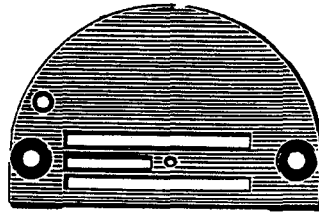

61324 C

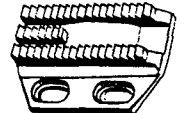

61305 C

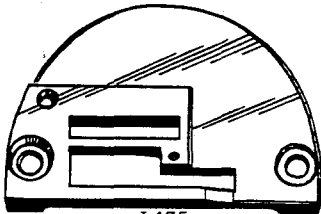

L435

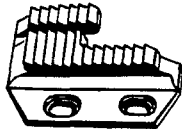

L436

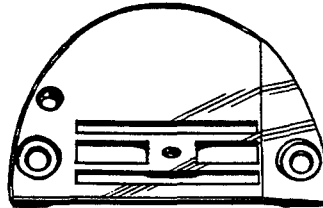

61324 J

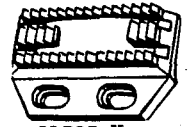

61305 K

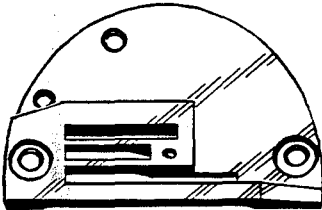

L437

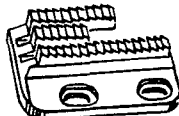

L438

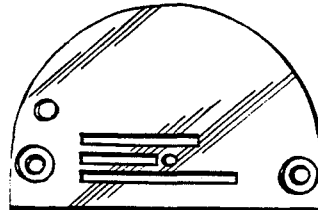

61324 N

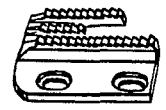

61305 N

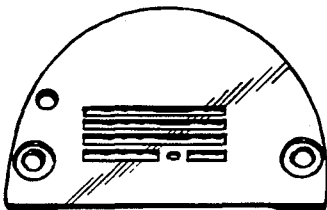

L549

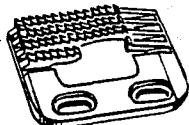

L550

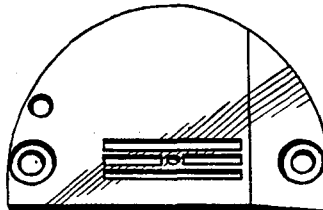

61324 Q

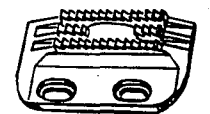

61305 Q

THROAT PLATE AND FEED DOG COMBINATIONS
FOR STYLE 61400 B

<u>Part No.</u>	<u>Description</u>
L83 A	With .063 inch needle hole, for binding plastics; feed dog No. 61305 U, presser foot No. L82 A (.156 inch thick)
L397	With .063 inch needle hole, for sewing sleeve facings to work shirts; feed dog No. L398, presser foot No. L440 (.250 inch thick)
L398	Teeth cut 16 per inch, for binding operations on jackets and work shirts; throat plate No. L397, presser foot No. L440
L435	With .063 inch needle hole, for upholstery operations, 3/16 inch cord; feed dog No. L436, presser foot No. 61420 BC (.250 inch thick at back)
L436	Teeth cut 12 per inch, for cording upholstery, 3/16 inch cord; throat plate No. L435, presser feet No. 61420 BC
L437	With .083 inch needle hole, for binding operation on jackets; feed dog No. L438, presser foot No. L440 (.190 inch thick at back)
L438	Teeth cut 16 per inch, for binding operations on jackets and work shirts; throat plate No. L437, presser foot No. L440
L549	With .073 inch needle hole, for attaching sleeve facings to work shirts; feed dog No. L550, presser foot No. 61420 H (.125 inch thick)
L550	Teeth cut 16 per inch, for attaching sleeve facings to work shirts; throat plate No. L549, presser foot No. 61420 H
61305 C	Teeth cut 14 per inch, for hemming high back overall suspenders; throat plate No. 61324 C-093, presser foot No. 61320 C
61305 K	Teeth cut 12 per inch, for seaming heavy weight trousers, coats and similar garments; throat plate No. 61324 J-093, presser foot No. 61320 S
61305 N	Teeth cut 16 per inch, for miscellaneous operations on work shirts; throat plate No. 61324 N-073, presser foot No. 61320 R
61305 Q	Teeth cut 16 per inch, for pants fly operation, using folder No. L186; throat plate No. 61324 Q-073, presser foot No. 61220
61305 U	Teeth cut 22 per inch, for hemming work shirts and binding plastics; throat plate No. L83 A or 61324 U-063, presser foot No. L82 A or 61420 BN
61324 C-083	With .083 inch needle hole for hemming high back overall suspenders; also in sizes .093, .125 inch needle holes; feed dog No. 61305 C, presser foot No. 61320 C (.125 inch thick)
61324 J-093	With .093 inch needle hole, for seaming heavy weight trousers, coats and similar garments; feed dog No. 61305 K, presser foot No. 61320 S (.125 inch thick)
61324 N-063	With .063 inch needle hole, for miscellaneous operations on work shirts; also in sizes .073, .093 inch needle holes; feed dog No. 61305 N, presser foot No. 61320 R (.125 inch thick)
61324 Q-073	With .073 inch needle hole, for pants fly operations, using folder No. L186; feed dog No. 61305 Q, presser foot No. 61220 (.125 inch thick)
61324 U-063	With .063 inch needle hole, for hemming work shirts; feed dog No. 61305 U, presser foot No. 61420 BN (.156 inch thick)

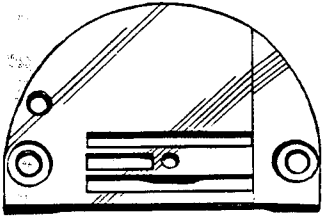

61324 R

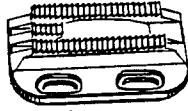

61305 T

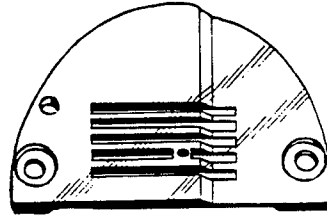

61424 Z

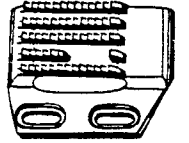

61405 K

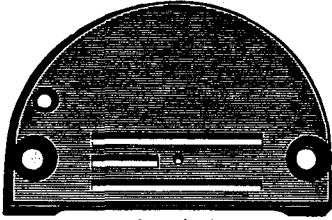

61324 A

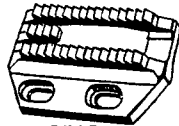

61305A

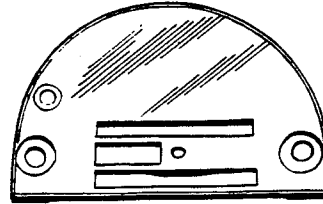

61424 N

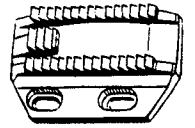

61405 N

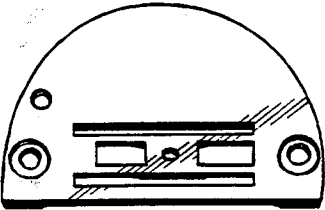

61424 C

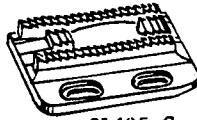

61405 C

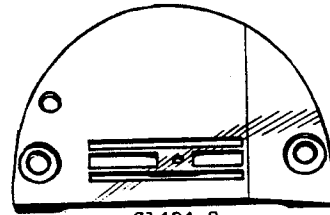

61424 S

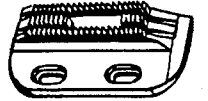

61405 S

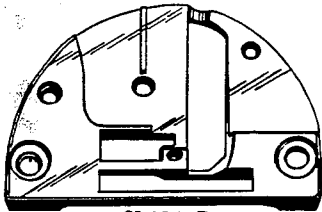

61424 T

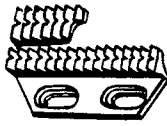

61405T

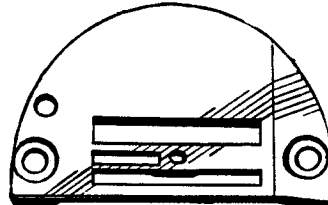

61424 G

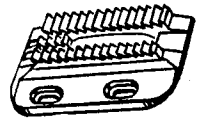

61405 G

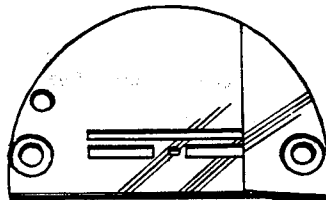

61424 H

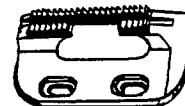

61405 H

THROAT PLATE AND FEED DOG COMBINATIONS
FOR STYLE 61400 B

<u>Part No.</u>	<u>Description</u>
61305 A	Teeth cut 14 per inch, for miscellaneous operations on work pants, dungarees and overalls; throat plate No. 61324 A-093, presser foot No. 61220 P
61305 T	Teeth cut 22 per inch, for miscellaneous seaming operations on coats and pants; throat plate No. 61324 R-093, presser foot No. 61220 P
61324 A-063	With .063 inch needle hole, for miscellaneous operations on work pants, dungarees and overalls; also in size .093, .125 inch needle holes; feed dog No. 61305 A, presser foot No. 61220 P (.125 inch thick)
61324 R-073	With .073 inch needle hole, for seaming operations on coats and pants; also in size .093 inch needle hole; feed dog No. 61305 T, presser foot No. 61220 P (.125 inch thick)
61405 C	Teeth cut 16 per inch, for sewing pocket facings with chaining between pockets; throat plate No. 61424 C-093, presser foot No. 61420 C
61405 G	Teeth cut 14 per inch, for cording couch covers; throat plate No. 61424 G-093, presser foot No. L189
61405 H	Teeth cut 22 per inch, for binding and hemming flannel shirts; throat plate No. 61424 H-063, presser foot No. L563
61405 K	Teeth cut 16 per inch, for sleeve facings on sport and work shirts; throat plate No. 61424 K-063, presser foot No. 61420 H
61405 N	Teeth cut 14 per inch, for miscellaneous operations on denim, canvas and other heavy materials; throat plate No. 61424 N-093, presser foot No. 61320 AA
61405 S	Teeth cut 22 per inch, for run stitching collar operations; throat plate No. 61424 S-063, presser foot No. 61420 BJ
61405 T	Teeth cut 16 per inch, for miscellaneous binding operations on heavy weight materials; throat plate No. 61424 T-093, presser foot No. 61220 H
61424 C-093	With .093 inch needle hole, for sewing on pocket facings, and chaining between pockets; feed dog No. 61405 C, presser foot No. 61420 C (.125 inch thick)
61424 G-093	With .093 inch needle hole, for cording couch covers and similar operations; feed dog No. 61405 G; presser foot No. L189 (.125 inch thick)
61424 H-063	With .063 inch needle hole, for binding and hemming on flannel shirts; feed dog No. 61405 H, presser foot No. L563 (.125 inch thick)
61424 K-063	With .063 inch needle hole, for sleeve facings on sport and work shirts; feed dog No. 61405 K, presser foot No. 61420 H (.109 inch thick at front, .203 inch thick at back)
61424 N-093	With .093 inch needle hole, for miscellaneous operations on denim, canvas and other heavy weight material; feed dog No. 61405 N, presser foot No. 61320 AA (.125 inch thick)
61424 S-063	With .063 inch needle hole, for run stitching collar operation on dress and work shirts; feed dog No. 61405 S, presser foot No. 61420 BJ (.125 inch thick)
61424 T-093	With .093 inch needle hole, for miscellaneous binding operations; feed dog No. 61405 T, presser foot No. 61220 H (.125 inch thick)

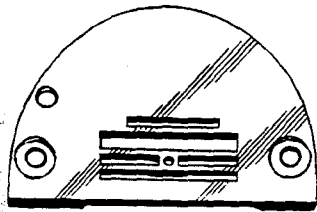

61424 F

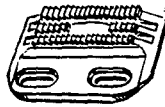

61405 F

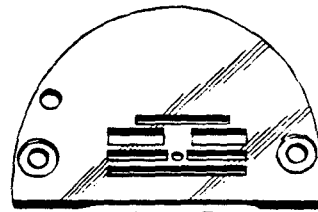

61424 E

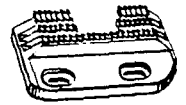

61405 E



61205C

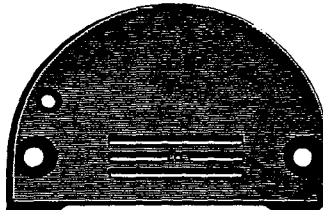

61224C

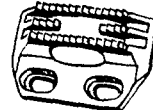

61205A

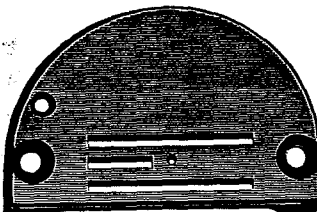

61324A

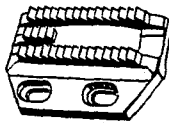

61305A

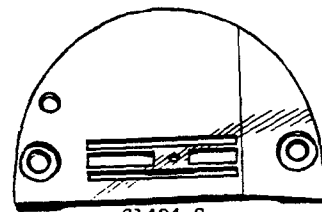

61424 S

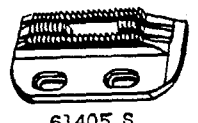

61405 S

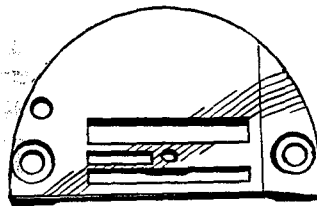

61424 G

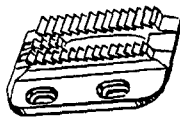

61405 G

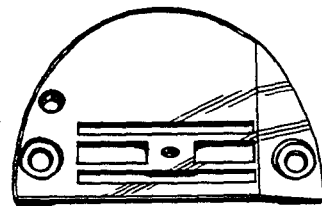

61324 J

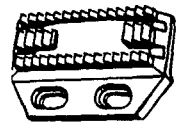

61305 K

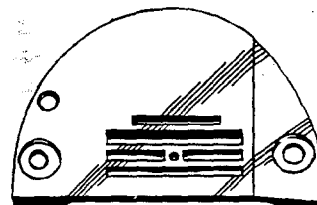

61424 A

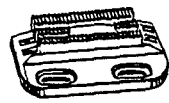

61405 A

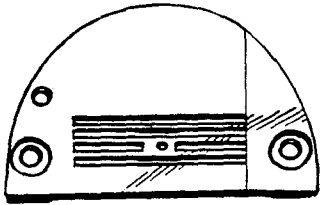

61424 B

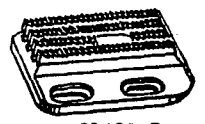

61405 B

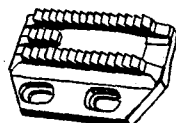

61305A

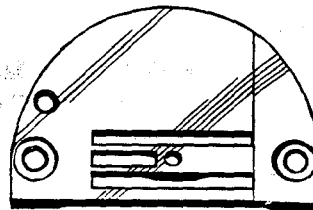

61324 R

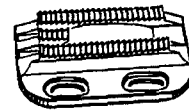

61205 T

THROAT PLATE AND FEED DOG COMBINATIONS
FOR STYLES 61400 N, 61400 P, 61400 R, 61400 S

<u>Part No.</u>	<u>Description</u>
61205 A	Teeth cut 16 per inch, for sewing on hip pocket cord, work and dress pants, throat plate No. 61224 C, presser feet Nos. 61320 AL, 61420 AA, top feed Nos. 61439 S, 61439 X
61205 C	Teeth cut 22 per inch, for hemming and attaching collar bands to work and dress shirts; throat plate No. 61224 C, presser feet Nos. 61320 AM, 61420 BK, top feed Nos. 61439 N, 61439 X, L925
*61224 C-063	With .063 inch needle hole, for attaching collar bands to work and dress shirts, and sewing on hip pocket cord to work and dress pants; also in sizes .043, .073, .083 inch needle holes; feed dog Nos. 61205 A, 61205 C, presser feet Nos. 61420 AA, 61420 BK, 61320 AL, 61320 AM, top feed Nos. 61439 N, 61439 S, 61439 X, L925
61305 A	Teeth cut 14 per inch, for top stitching waistbands to work pants; throat plate Nos. 61324 A, 61324 R, presser foot No. 61420 J, top feed No. 61439 U
61305 K	Teeth cut 12 per inch, for sleeve facing and hemming sport shirts; throat plate No. 61324 J, presser foot No. L926, top feed No. 61439 T
61305 T	Teeth cut 22 per inch, for seaming on two or more ply materials; throat plate No. 61324 R, presser feet Nos. L39 A, 61320 AL, top feed No. 61439 S
61324 A-063	With .063 inch needle hole, for top stitching waistbands to work pants; also in sizes .093, .125 inch needle holes; feed dog No. 61305 A, presser foot No. 61420 J, top feed No. 61439 U
61324 J-093	With .093 inch needle hole, for sleeve facing and hemming sport shirts; feed dog No. 61305 K, presser foot No. L926, top feed No. 61439 T
61324 R-073	With .073 inch needle hole, for seaming heavy materials two or more plies; also in size .093 inch needle hole; feed dog Nos. 61305 A, 61305 T, presser feet Nos. 61320 AL, L39 A, top feed No. 61439 S
61405 A	Teeth cut 32 per inch, for top stitching zippers to rayon; throat plate No. 61424 A, presser foot No. 61420 BK, top feed No. 61439 W
61405 B	Teeth cut 22 per inch, for attaching sleeve facings to work shirts, jackets and children's garments; throat plate No. 61424 B, presser feet Nos. 61420 AA, 61420 AB, top feed Nos. 61439 T, 61439 V, L925
61405 E	Teeth cut 22 per inch, for attaching waistbands to trousers; throat plate No. 61424 E, presser foot No. 61420 BK, top feed No. 61439 S
61405 F	Teeth cut 22 per inch, for piping pillow slips; throat plate No. 61424 F, presser foot No. L17 A, top feed No. 61439 V
61405 G	Teeth cut 14 per inch, for hemming and seaming on heavy wool shirts and pants, throat plate No. 61424 G, presser feet Nos. 61320 X, L926, top feed Nos. 61439 T, L955
61405 S	Teeth cut 22 per inch, for hemming bottoms of sport shirts; throat plate No. 61424 S, presser foot No. 61420 AB, top feed No. 61439 T
61424 A-063	With .063 inch needle hole, for top stitching zippers to rayon material; feed dog No. 61405 A, presser foot No. 61420 BK, top feed No. 61439 W
61424 B-063	With .063 inch needle hole, for attaching sleeve facings to work shirts, jackets and children's garments; feed dog No. 61405 B, presser feet Nos. 61420 AA, 61420 AB, top feed Nos. 61439 T, 61439 V, L925
*61424 E-063	With .063 inch needle hole, for attaching waistbands to trousers; feed dog No. 61405 E, presser foot No. 61420 BK, top feed No. 61439 S
*61424 F-063	With .063 inch needle hole, for piping pillow slips; feed dog No. 61405 F, presser foot No. L17 A, top feed No. 61439 V
61424 G-093	With .093 inch needle hole, for top stitching waistbands and hemming on shirts and pants; feed dog No. 61405 G, presser feet Nos. 61320 X, L926, top feed Nos. 61439 T, L955
61424 S-063	With .063 inch needle hole, for hemming bottoms of sport shirts; feed dog No. 61405 S, presser foot No. 61420 AB, top feed No. 61439 T

* Thin Throat Plates .085 inch thick for use on Styles 61400 N, 61400 P only. All other plates listed for use on Styles 61400 R, 61400 S

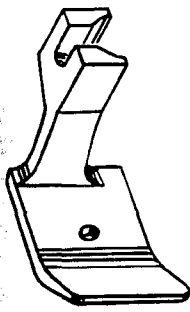

61420 U

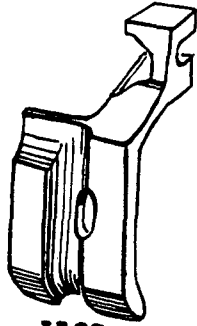

L189



61220 AB

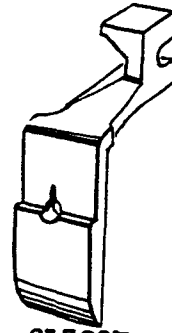

61320K

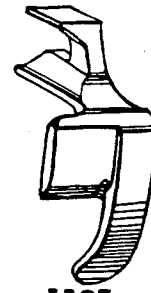

L193

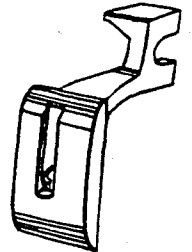

L217

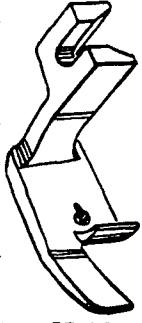

61420 BE

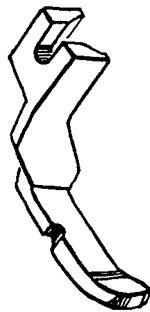

61220 V

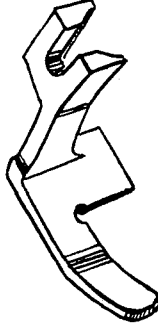

L290



L205



L368

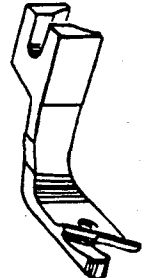

61420 BG

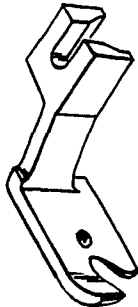

L298

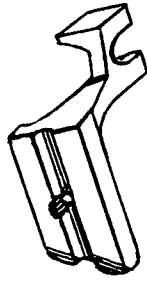

61420 N

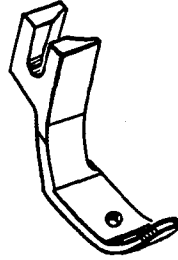

61220T

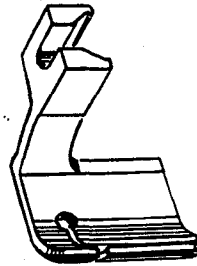

61420 S

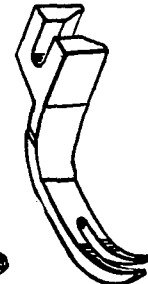

61320 AC

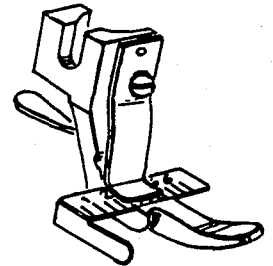

L769

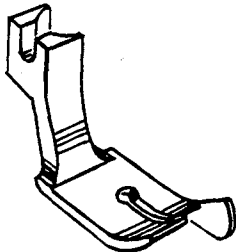

61420 E



L429



61420 AH

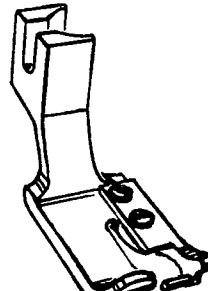

L768

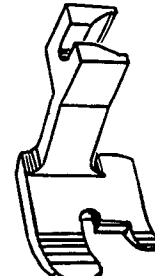

L518

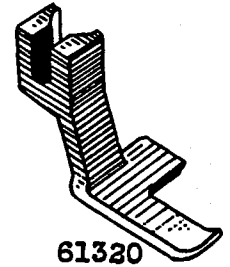

61320

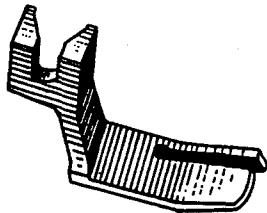

61420 AJ

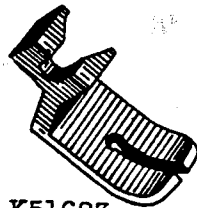

K51683

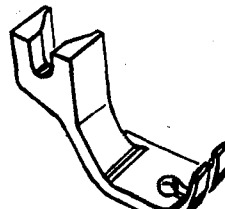

61420 F

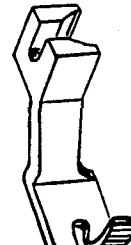

L506

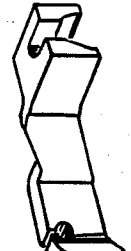

61420 V

PRESSER FEET

<u>Part No.</u>	<u>Description</u>
L189	For cording couch covers, 1/4 inch cord groove 1/32 inch to right of needle; feed dog No. 61405 G, throat plate No. 61424 G
L193	For edge stitching coats, right toe cut off at needle; feed dog No. 61305 B, throat plate No. 61324 B-073
L205	For miscellaneous hemming, used with 3/16 inch plate hemmer; feed dog No. L206, throat plate No. L143
L217	For braiding sport shirts and similar garments, 7/64 inch braiding groove in center of needle; feed dog No. 61205 A, throat plate No. 61224 C-083
L290	For edge stitching coats and similar garments; feed dog No. 61305 G, throat plate No. 61324 F-093
L298	For quilting operations; throat plate No. 61424 V, feed dog No. 61405 V
L368	For hemming handkerchiefs, feed dog No. L369, throat plate No. L391
L429	For zipper tab operation; feed dog No. 61205, throat plate No. 61224 C-063
L506	For edge stitching light weight materials; feed dog No. 61205 C, throat plate No. 61224 C-063
L518	For edge stitching sack coats; feed dog No. L520, throat plate No. L519
L768	For top stitching collars; guide 3/16 inch to right of needle; feed dog No. L223, throat plate No. L222 (screw for guide No. 22738)
L769	With adjustable guide for quilting, 1/16 inch to 7/8 inch margin to left of needle; feed dog No. 61405 M, throat plate No. 61424 M (spring release lever No. 61330 P, spring No. 61330 N, screw No. 22547 A)
K51683	For attaching cuffs to shirts; feed dog No. 61305 A, throat plate No. 61324 A-093
61220 T	For hemming towels; feed dog No. 61205 A, throat plate No. 61224 C-073
61220 V	For zipper tab operations; feed dog No. 61205 A, throat plate No. 61224 C-073
61220 AB	For edge stitching; feed dog No. 61205 A, throat plate No. 61224 C-063
61320	For edge stitching on men's suits, coats; feed dog No. 61305 B, throat plate No. 61324 B-093
61320 K	For shirring light weight house dresses; feed dog No. 61205 A, throat plate No. 61224 C-073
61320 AC	For attaching hook and eye strips to corsets; feed dog No. 61305 S, throat plate No. 61224 C-043
61420 E	For edge stitching, guide extends 1/4 inch to right of needle; feed dog No. 61305 A, throat plate No. 61324 A-093
61420 F	For hemming work shirts, used with plate hemmer; feed dog No. 61205 A, throat plate No. 61224 C-063
61420 N	For piping pajama fronts and collars, 3/32 inch prepared piping; feed dog No. 61205 A, throat plate No. 61224 C-063
61420 S	For attaching sleeve facing to work shirts, foot extends 3/4 inch to right of needle; feed dog No. 61405 K, throat plate No. 61424 K
61420 U	For pants flies, one operation; folder No. L186, feed dog No. 61205 A, throat plate No. 61224 C-083
61420 V	For sewing zipper tabs to pants flies, 1/16 inch margin to left of needle; feed dog No. 61405 R, throat plate No. 61424 R
61420 AH	For top stitching shirt collars, pajamas, 3/16 inch margin to right of needle; feed dog No. 61405 J, throat plate No. 61424 J-063
61420 AJ	For edge stitching pockets on dresses, shirts, 1/32 inch margin to right of needle; feed dog No. 61405 Z, throat plate No. 61224 B-063
61420 BE	For miscellaneous binding on rayon and similar material; feed dog No. 61305 P, throat plate No. 61324 P-063
61420 BG	For hemming bed sheets; feed dog No. 61205 C, throat plate No. 61224 C-063

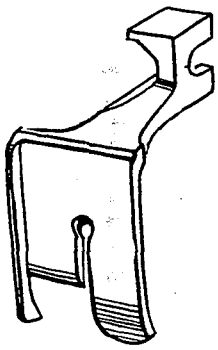

61420 AK

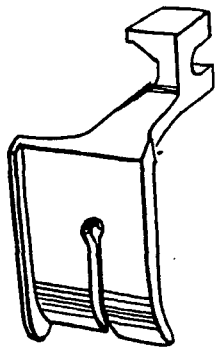

61420 AG

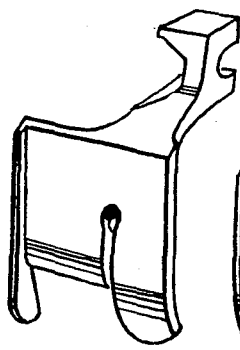

61420 AM

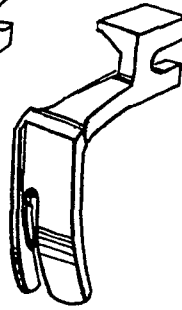

61320 AB

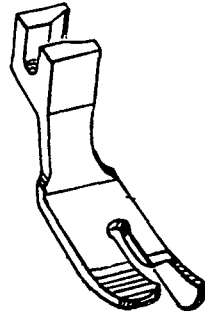

61420 BH

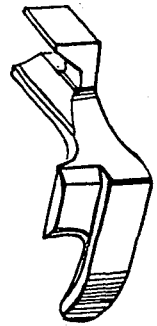

61420 AL



L17

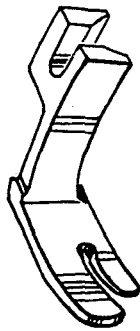

61320 P

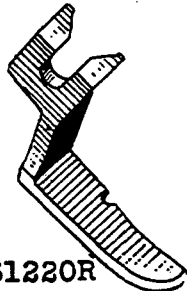

61220R

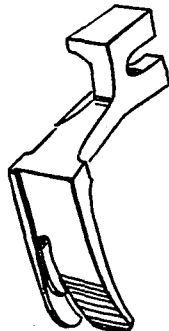

61220N

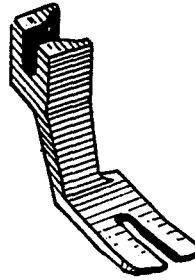

61220G



61320 M

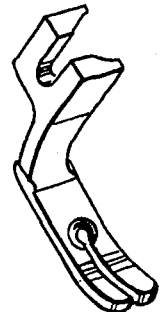

61420 P



61220H

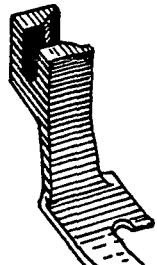

61320B

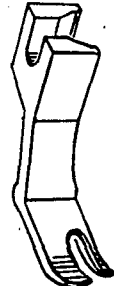

61420 R

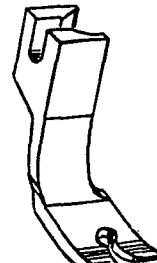

L546

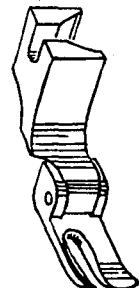

61320 AF

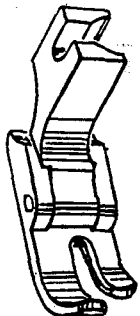

61420 AW

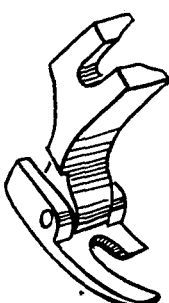

L266

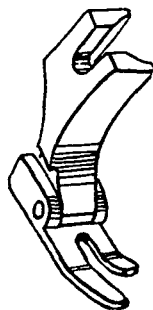

K51687

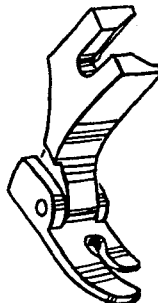

61320 R

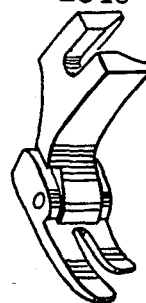

61420 AV

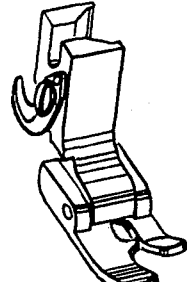

L218

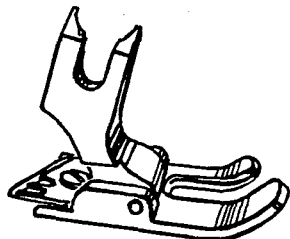

61420 C

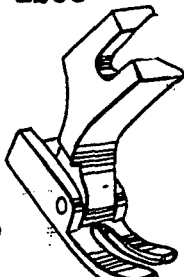

L195

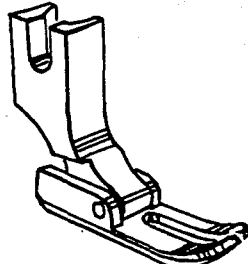

61420 BJ

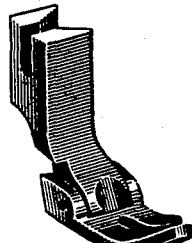

61220J

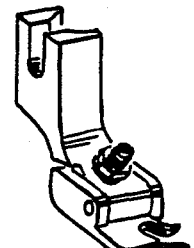

L82 A

PRESSER FEET

<u>Part No.</u>	<u>Description</u>
L17	For edge stitching collars, left side of bottom .030 inch lower; feed dog No. 61205 A, throat plate No. 61224 C-073
L82 A	For binding plastics; feed dog No. 61305 U, throat plate No. L83 A (adjusting screw No. 22840 A, lock nut No. 51430 F, hinge pin No. 61330 B-39)
L195	For miscellaneous shirt operations; feed dog No. 61205 A, throat plate No. 61224 C-063 (shank No. 61330 AC, hinge pin No. 61330 B-29)
L218	For edge stitching dress shirt collars; feed dog No. 61205 A, throat plate No. 61224 C-063 (pin No. 1741 A, knife No. 1741 B, screw No. 187 A)
L266	For miscellaneous operations on suit pants and coats; feed dog No. 61305 E, throat plate No. 61324 E-073 (hinge pin No. 61330 B-35, shank No. 61330 AC)
L546	For miscellaneous binding; feed dog No. L398, throat plate No. L397
K51687	For miscellaneous seaming on light weight material; feed dog No. 61205 C, throat plate No. 61224 C-063 (shank No. 61330 AC, hinge pin No. 61330 B-29)
61220 G	For hemming work shirts, used with plate hemmer; feed dog No. 61205 A, throat plate No. 61224 C-063
61220 H	For miscellaneous binding operations on melton jackets; feed dog No. L659, throat plate No. 61224 D-093
61220 J	For seaming light and medium weight woven material, has spring for raising toe; feed dog No. 61205 C, throat plate No. 61224 C-063 (spring No. 61230 AK, shank No. 61330 AC, bottom No. 61330 Z, hinge pin No. 61330 B-31)
61220 N	For attaching labels, guide 1/16 inch to right of needle; feed dog No. 61205 A, throat plate No. 61224 C-063
61220 R	For zipper tab operations; feed dog No. 61205 A, throat plate No. 61224 C-073
61320 B	For edge stitching on men's pants; feed dog No. 61305, throat plate No. 61324-093
61320 M	For attaching zippers to light weight garments; feed dog No. 61205 A, throat plate No. 61224 C-063
61320 P	For miscellaneous seaming; feed dog No. 61305 D, throat plate No. 61324 D-073
61320 R	For plain seaming operations on work shirts; feed dog No. 61305 N, throat plate No. 61324 N-073 (shank No. 61330 AC, bottom No. 61330 AF, hinge pin No. 61330 B-31)
61320 AB	For edge stitching on pants flies, guide 1/16 inch to right of needle, feed dog No. 61205 A, throat plate No. 61224 C-073
61320 AF	For sewing zipper tabs to various type garments; feed dog No. 61205 A, throat plate No. 61224 C-063
61420 C	For sewing on pocket facing to trousers and chaining between pockets, foot equipped with chain cutting knife; feed dog No. 61405 C, throat plate No. 61424 C-093 (bottom No. 61430 C, screw No. 73 A, knife No. 61430 A, knife guard No. 61430 B, hinge pin No. 61330 B-35, spring No. 51930, shank No. 61330)
61420 P	For tacking pants flies; feed dog No. 61205 C, throat plate No. 61224 C-063
61420 R	For sewing zipper tabs to pants flies; feed dog No. 61205 A, throat plate No. 61224 C-083
61420 AG	For edge stitching work jackets, 3/8 inch margin to right of needle; feed dog No. 61205 D, throat plate No. 61224 F-063
61420 AK	For edge stitching on light to heavy materials, 3/8 inch margin to right of needle; feed dog No. 61305 A, throat plate No. 61324 A-093
61420 AL	For edge stitching pants flies, 1/32 inch margin to left of needle; feed dog No. 61305 B, throat plate No. 61324 B-093
61420 AM	For edge stitching, 1/2 inch margin to right of needle; feed dog No. L119, throat plate No. L118
61420 AV	For miscellaneous seaming on dresses and shirts made of light weight woven materials; feed dog No. 61205 E, throat plate No. 61224 E-063 (spring No. 51930, hinge pin No. 61330 B-29)
61420 AW	For miscellaneous seaming on dress pants and suits made of cotton and wool materials; feed dog No. 61305 C, throat plate No. 61324 C-093 (shank No. 61330)
61420 BH	For edge stitching, guide extends 1/8 inch to right of needle; feed dog No. 61305 A, throat plate No. 61324 A-093
61420 BJ	For collar operation on dress shirts; feed dog No. 61405 S, throat plate No. 61424 S-063 (shank No. 61330, bottom No. 61330 T, hinge pin No. 61330 B-39)

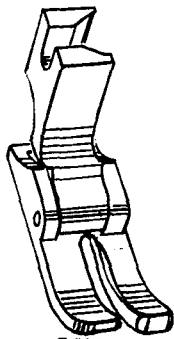

L72

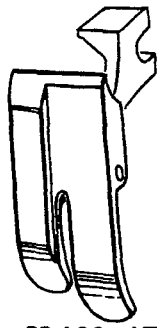

61420 AE

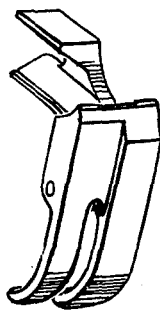

61320 L

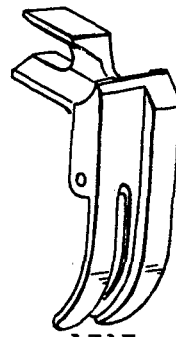

L313

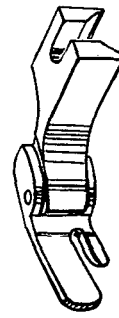

61420 AX

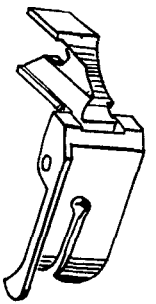

61420 AD

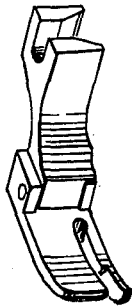

61420 AF

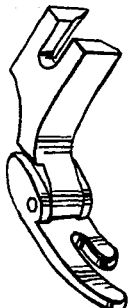

L326

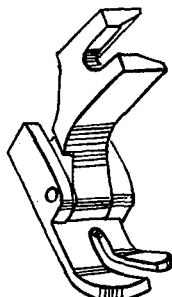

L64

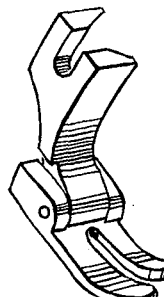

61220P

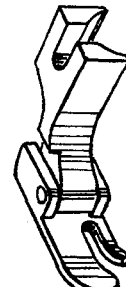

61420 AZ

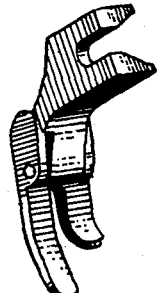

61420 AY

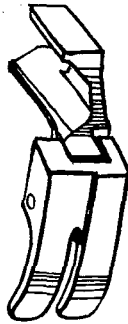

L69

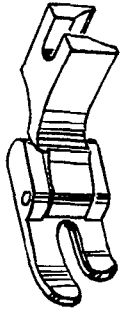

61320 Q

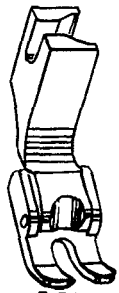

L95

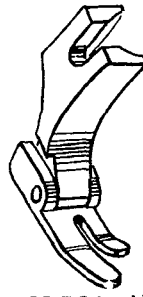

61320 AD

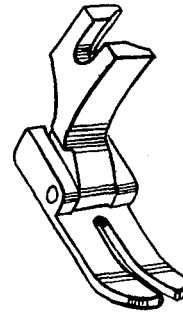

61320 S

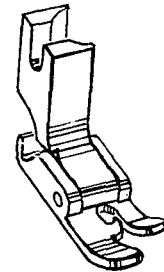

61320 Z

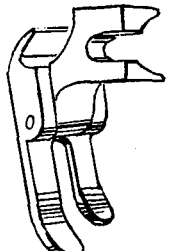

61320 AA

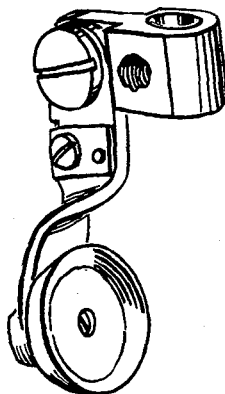

61420 BA

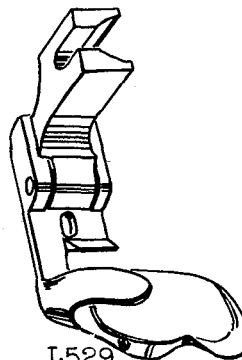

L529

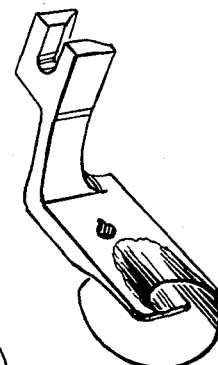

L748

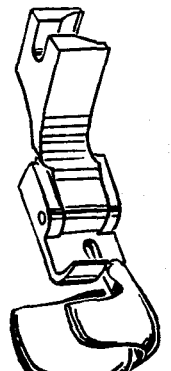

L408

PRESSER FEET

<u>Part No.</u>	<u>Description</u>
L64	For hemming overall suspender straps; feed dog No. 61305 M, throat plate No. 61324 L-093 (shank No. 61330)
L69	For hemming overall suspenders, left side of bottom 1/16 inch lower, 1/16 inch to left of needle; feed dog No. 61205 A, throat plate No. 61324 C-063 (shank No. 61230 D, hinge pin No. 61330 B-29)
L72	For edge stitching, right side of bottom 1/32 inch lower, 1/16 inch to right of needle; feed dog No. 61305 C, throat plate No. 61324 C-063 (shank No. 61330, hinge pin No. 61330 B-35)
L95	For miscellaneous seaming operations; feed dog No. 61205 A, throat plate No. 61224 C-063 (shank No. 61330 AC, hinge pin No. 61330 B-29)
L313	For edge stitching, left side of bottom 1/16 inch lower, 1/16 inch to left of needle; feed dog No. 61305 A, throat plate No. 61324 A-093 (shank No. 61330, hinge pin No. 61330 B-35)
L326	For miscellaneous seaming, 5/16 inch feed surface in back of needle; feed dog No. 61305 B, throat plate No. 61324 B-093 (shank No. 61330 AC, hinge pin No. 61330 B-29)
L408	For attaching yokes, 5/16 inch turned down fold; feed dog No. 61205 A, throat plate No. 61224 C-063 (shank No. 61230 D, hinge pin No. 61330 B-29)
L529	For attaching yokes, 3/16 inch turned down fold; feed dog No. 61205 B, throat plate No. 61224 C-063 (hinge pin No. 61330 B-35)
L748	For hemming dresses, material enters from left, 1/4 inch turned up hem; feed dog No. 61205 A, throat plate No. 61224 C-063
61220 P	For miscellaneous operations on medium weight materials, has spring for raising toe; feed dog No. 61305 K, throat plate No. 61324 A-093 (shank No. 61330, spring No. 51930, bottom No. 61330 AG, hinge pin No. 61330 B-35)
61320 L	For hemming overall suspenders, guide 1/16 inch to left of needle; feed dog No. 61305 A, throat plate No. 61324 A-093 (bottom No. 61330 L, shank No. 61330, hinge pin No. 61330 B-35)
61320 Q	For tacking flies to overalls; feed dog No. L33 A, throat plate No. 61324 D-063 (shank No. 61330, bottom No. 61330 R, hinge pin No. 61330 B-35)
61320 S	For miscellaneous operations on heavy coats, trousers and similar operations; feed dog No. 61305 K, throat plate No. 61324 J-093 (shank No. 61330, bottom No. 61330 T, hinge pin No. 61330 B-35)
61320 Z	For tacking pants flies; feed dog No. 61205 A, throat plate No. 61224 C-063 (hinge pin No. 61330 B-29, shank No. 61330 AC, bottom No. 61330 AA)
61320 AA	For miscellaneous operations on denim, canvas and other heavy materials; feed dog No. 61305 C, throat plate No. 61324 C-093 (shank No. 61330, bottom No. 61330 AB, hinge pin No. 61330 B-35)
61320 AD	For miscellaneous seaming operations on rayon and other light materials; feed dog No. 61205 C, throat plate No. 61224 C-063 (hinge pin No. 61330 B-31, spring No. 61230 AK, bottom No. 61330 AU, shank No. 61330 AC)
61420 AD	For edge stitching coats, jackets, 3/16 inch margin to right of needle; feed dog No. 61205 A, throat plate No. 61224 C-083 (shank No. 61330, hinge pin No. 61330 B-39)
61420 AE	For edge stitching overall suspenders, 1/16 inch margin to right of needle; feed dog No. 61305 C, throat plate No. 61324 C-093 (shank No. 61330, hinge pin No. 61330 B-35)
61420 AF	For edge stitching shirts and dresses, 1/32 inch margin to right of needle; feed dog No. L224, throat plate No. 61224 B-063 (hinge pin No. 61330 B-29)
61420 AX	For sewing zipper tabs to pants flies; feed dog No. 61205 E, throat plate No. 61224 E-063 (hinge pin No. 61330 B-29)
61420 AY	For miscellaneous seaming on work and dress pants; feed dog No. 61205 A, throat plate No. 61224 C-063 (shank No. 61230 D, hinge pin No. 61330 B-29)
61420 AZ	For sewing zipper tabs; feed dog No. 61205 E, throat plate No. 61224 E-063 (shank No. 61330, hinge pin No. 61330 B-29)
61420 BA	For miscellaneous seaming on leather; feed dog No. L55, throat plate No. L54 (roller No. 1580 G-13, axle screw No. 22818, locking spring screw No. 22743, arm pivot screw No. 14076, spring guide screw No. 22561, spring No. 61430 L, screw No. 88) Also order one each No. 61257 G upper presser bar bushing, 61457 D lower presser bar bushing and 51957 D presser bar

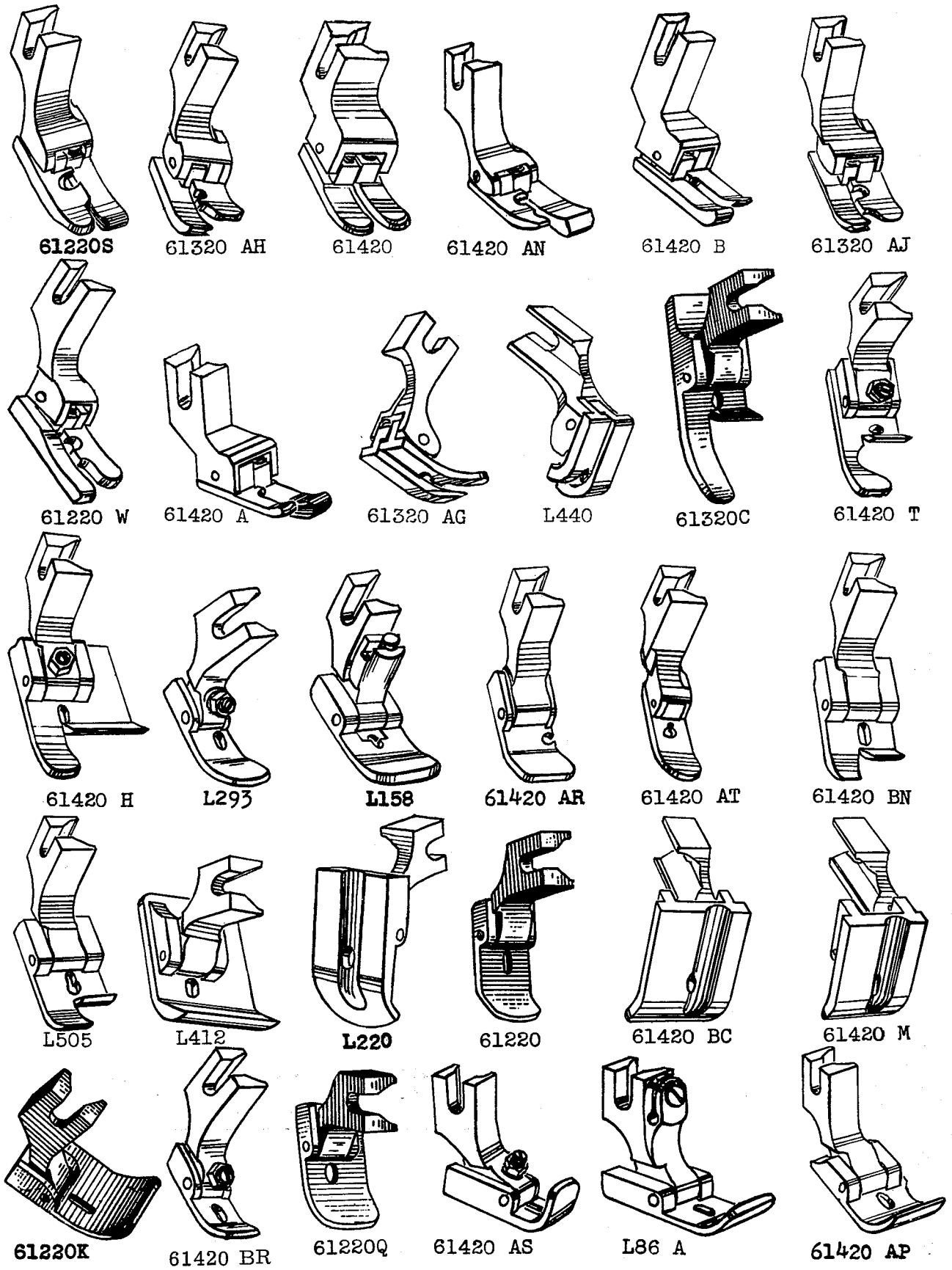

PRESSER FEET

<u>Part No.</u>	<u>Description</u>
L86 A	For welt seaming pants, one operation, split shank for guide; feed dog No. 61305 C, throat plate No. 61324 C-093
L158	For miscellaneous seaming, chaining section behind needle; feed dog No. 61305 A, throat plate No. 61324 A-093 (bottom No. 61330 V, yielding section No. 61330 W, spring No. 1230 B)
L220	For cording couch covers, 3/16 inch cord groove 1/32 inch to left of needle; feed dog No. 61305 A, throat plate No. 61324 A-093 (shank No. 61330)
L293	For miscellaneous house dress operations; feed dog No. 61205, throat plate No. 61224-063 (adjusting screw No. 51430 F, nut No. 22840 A)
L412	For making pants flies with folder No. L464, feed dog No. 61305 A, throat plate No. 61324 A-093 (spring No. 51930, hinge pin No. 61330 B-29, shank No. 61230 D)
L440	For binding operation on jackets and work shirts; feed dog No. L438, throat plate No. L437
L505	For miscellaneous hemming operations, guide on left of needle; feed dog No. 61305 C, throat plate No. 61324 C-093 (shank No. 61330, hinge pin No. 61330 B-35)
61220	For pants fly operations, using folder No. L186; feed dog No. 61305, throat plate No. 61324 Q-073 (shank No. 61330, bottom No. 61330 Y, hinge pin No. 61330 B-31)
61220 K	For attaching sleeve facings to shirts; feed dog No. 61405 K, throat plate No. 61424 K-063 (spring No. 51930, shank No. 61330 AC, bottom No. 61330 AD, hinge pin No. 61330 B-29)
61220 Q	For hemming pants flies; feed dog No. 61205 C, throat plate No. 61224 C-063 (spring No. 51930, bottom No. 61330 AE, shank No. 61330 AC, hinge pin No. 61330 B-29)
61220 S	For stitching shirt pockets, right side yielding; feed dog No. 61205 A, throat plate No. 61224 C-063 (spring No. 51930, hinge pin No. 61330 B-35, bottom No. 61230 L, yielding section No. 61230 M, shank No. 61230 S)
61220 W	For edge stitching pockets, right side yielding; feed dog No. L579, throat plate No. L580 (spring No. 51930, hinge pin No. 61330 B-35, bottom No. 61230 V, yielding section No. 61230 W, shank No. 61230 X)
61320 C	For hemming high back overall suspenders; feed dog No. 61305 C, throat plate No. 61324 C-093 (shank No. 61330, bottom No. 61330 C, hinge pin No. 61330 B-29)
61320 AG	For edge stitching shirt pockets, right side yielding; feed dog No. 61205 C, throat plate No. 61224 C-063 (shank No. 61330 AK, spring No. 51930, hinge pin No. 61330 B-35, bottom No. 61330 AJ, yielding section No. 61330 AL)
61320 AH	For edge stitching shirt pockets, left side yielding; feed dog No. 61205 C, throat plate No. 61224 C-063 (yielding section No. 61330 AN, spring No. 51930, bottom No. 61330 AM, hinge pin No. 61330 B-31, shank No. 61330 AP)
61320 AJ	For edge stitching shirt pockets, left side yielding; feed dog No. 61205 C, throat plate No. 61224 C-063 (spring No. 51930, hinge pin No. 61330 B-35, shank No. 61230 X, bottom No. 61330 AR, yielding section No. 61330 AS)
61420	For stitching down waistbands on pants, both sides yielding; feed dog No. 61305 A, throat plate No. 61324 A-093
61420 A	For second operation attaching collars, right side yielding; feed dog No. 61205 A, throat plate No. 61224 C-063
61420 B	For second operation attaching collars, left side yielding; feed dog No. 61205 A, throat plate No. 61224 C-063
61420 H	For attaching sleeve facings to shirts; feed dog No. 61405 K, throat plate No. 61424 K-063 (shank No. 61330 AH, adjusting screw No. 51430 F, nut No. 22840 A, hinge pin No. 61330 B-35)
61420 M	For piping upholstery, furniture and automobile cushions, 5/32 inch piping; feed dog No. L436, throat plate No. L435 (hinge screw No. 22799 B)
61420 T	For binding; feed dog No. 61305 B, throat plate No. 61324 B-063 (hinge adjusting screw nut No. 51430 F, screw No. 22840 A, hinge pin No. 61330 B-35)
61420 AN	For setting shirt pockets, 1/32 inch margin; feed dog No. 61205 C, throat plate No. 61224 C-063 (bottom No. 61230 L, spring No. 51930, hinge pin No. 61330 B-35)
61420 AP	For one operation pants fly, for medium weight materials; folder No. L495, feed dog No. 61305 A, throat plate No. 61324 A-093 (shank No. 61330, hinge pin No. 61330 B-35)
61420 AR	For miscellaneous edge stitching, 1/32 inch margin; edge guide No. 61303, feed dog No. 61205 E, throat plate No. 61224 E-063 (hinge pin No. 61330 B-29)
61420 AS	For miscellaneous operations on plastics; feed dog No. 61305 U, throat plate No. 61324 U-063 (nut No. 51430 F, adjusting screw No. 22840 A, shank No. 61330 AH, hinge pin No. 61330 B-29)
61420 AT	For miscellaneous operations on silks, rayon and light weight materials; feed dog No. 61205 C, throat plate No. 61224 C-063
61420 BC	For cording upholstery, 3/16 inch cord groove to left of needle; feed dog No. L436, throat plate No. L435 (hinge screw No. 22799 B)
61420 BN	For hemming work shirts, 1/16 inch margin to left of needle; feed dog No. 61205 CA, throat plate No. 61224 C-063
61420 BR	For miscellaneous seaming on plastics; feed dog No. 61305 U, throat plate No. 61324 U-063 (adjusting screw No. 22840 A, nut No. 51430 F)

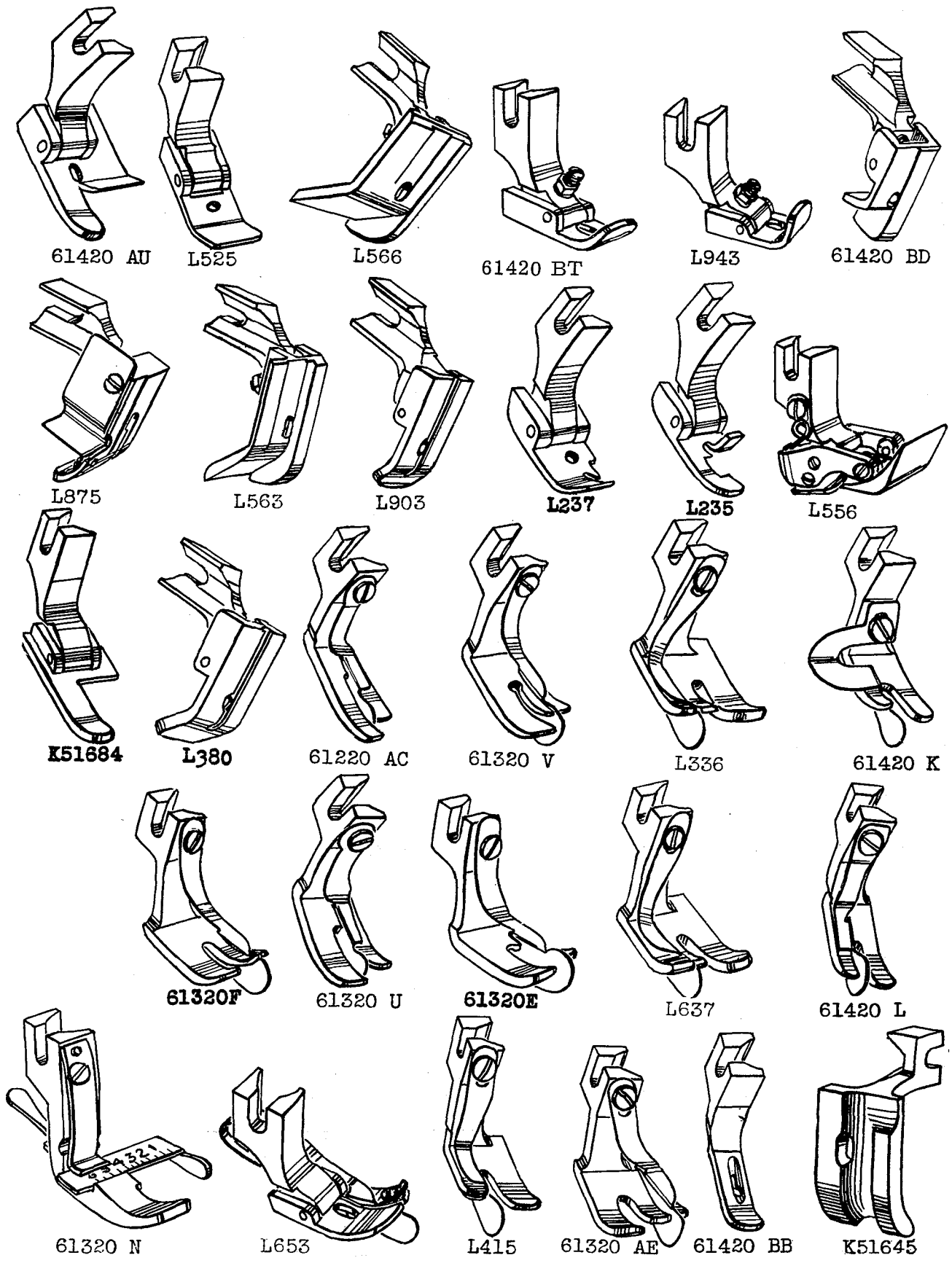

PRESSER FEET

<u>Part No.</u>	<u>Description</u>
L235	For miscellaneous hemming operations; feed dog No. 61305 A, throat plate No. 61324 A-093 (shank No. 61330, bottom No. 61330 B)
L237	For miscellaneous binding or hemming; feed dog No. 61305 B, throat plate No. 61324 B-093 (shank No. 61330, hinge screw No. 61330 B-35)
L336	For edge stitching, spring guide located 1/4 inch to left of needle; feed dog No. 61305 A, throat plate No. 61324 A-093 (spring guide No. L683, screw No. 187 A)
L380	For cording and piping pajama coats; feed dog No. 61305 B, throat plate No. 61324 B-063 (shank No. 61330)
L415	For edge stitching on heavy materials, 3/32 inch margin to left of needle; feed dog No. 61205 D, throat plate No. 61224 F-083 (spring guide No. 61330 E, screw No. 187 A)
L525	For hemming cuffs and collar bands, used with hemmer folder; feed dog No. 61205 A, throat plate No. 61224 C-073 (shank No. 61230 D, hinge pin No. 61330 B-29)
L556	For hemming heavy shirts and jackets, tractor type; feed dog No. 61305 A, throat plate No. 61324 A-093 (rear section No. 35730 C, yoke No. 25730 D, yoke screw No. 22799 E, hinge screw No. 22801, spring screw No. 226)
L563	For hemming flannel shirts, left edge guide; feed dog No. 61405 H, throat plate No. 61424 H (shank No. 61330, hinge pin No. 61330 B-35, adjusting screw No. 51430 F, nut No. 22840 A)
L566	For sleeve facing, left edge guide 5/16 inch from center of needle; feed dog No. 61405 K, throat plate No. 61424 K (shank No. 61330, adjusting screw No. 51430 F, nut No. 22840 A, hinge screw No. 61330 B-35)
L637	For edge stitching, spring guide located 3/16 inch to left of needle; feed dog No. 61305 A, throat plate No. 61324 A-093 (spring guide No. 61330 F, screw No. 187 A)
L653	For hemming, with plate hemmer, margin to right of needle; feed dog No. 61405 L, throat plate No. 61424 L (shank No. 61330 AC, hinge pin No. 61330 B-29, spring No. 51930, spring guide No. L122 A, screw No. 73 A)
L875	For miscellaneous seaming; feed dog No. 61305 C, throat plate No. 61324 C-093 (spring No. 51930, shank No. 61330 AC, hinge pin No. 61230 B-29, chip guard screw No. 22798)
L903	For cording pajama collars and similar garments, 1/16 inch cord groove 1/32 inch to left of needle; feed dog No. 61205 A, throat plate No. 61224 C-083 (hinge screw No. 22799 B)
L943	For miscellaneous seaming on plastics; feed dog No. 61305 U, throat plate No. 61324 U-063 (adjusting screw No. 51430 F, nut 22840 A, hinge pin No. 61330 B-29)
K51645	For cording upholstery, 9/32 inch cord groove 1/32 inch to left of needle; feed dog No. 61305 K, throat plate No. 61324 J-093
K61584	For binding operations, left edge guide; feed dog No. 61305 B, throat plate No. 61324 B-093 (shank No. 61330, hinge pin No. 61330 B-29)
61220 AC	For edge stitching collar bands, guide 3/64 inch to right of needle; feed dog No. 61205 A, throat plate No. 61224 C-063 (guide No. 61230 U, screw No. 187 A)
61320 E	For edge stitching overall pockets; guide 3/32 inch to right of needle; feed dog No. 61305 A, throat plate No. 61324 A-093 (guide No. 61330 E, screw No. 187 A)
61320 F	For edge stitching overall pockets, guide located 3/16 inch to right of needle; feed dog No. 61305 A, throat plate No. 61324 A-093 (guide No. 61330 F, screw No. 187 A)
61320 N	For edge stitching, adjustable guide; feed dog No. 61205 B, throat plate No. 61224 B-063 (main section No. 61330 M, spring No. 61330 N, spring release lever No. 61330 P, guide No. 61330 Q, screw No. 22547 A)
61320 U	For edge stitching overalls, guide 1/16 inch to right of needle; feed dog No. 61305 A, throat plate No. 61224 C-063 (spring guide No. 61230 U, screw No. 187 A)
61320 V	For edge stitching overall pockets; guide 1/8 inch to right of needle; feed dog No. 61305 A, throat plate No. 61324 A-093 (guide No. 61330 E, screw No. 187 A)
61320 AE	For miscellaneous edge stitching, spring guide located 1/4 inch to right of needle; feed dog No. 61305 A, throat plate No. 61324 A-093 (guide No. 61330 F, screw No. 187 A)
61420 K	For setting pockets, 1/16 inch margin to left of needle; feed dog No. 61305 A, throat plate No. 61324 A-093 (spring guide No. L357, screw No. 22561)
61420 L	For setting pockets to work shirts, spring guide 1/16 inch to left of needle; feed dog No. 61205 C, throat plate No. 61224 C-083 (spring guide No. L594, screw No. 187 A)
61420 AU	For hemming pajama coats, 5/8 inch hem, 9/16 inch margin to right of needle; feed dog No. 61405 K, throat plate No. 61424 K (shank No. 61330, hinge pin No. 61330 B-35)
61420 BB	For miscellaneous seaming and hemming silk, rayon; feed dog No. 61205 C, throat plate No. L63
61420 BD	For yoking shirts, guide extends 1/32 inch to left of needle; feed dog No. 61405 M, throat plate No. 61424 M (shank No. 61330 AC, hinge pin No. 61330 B-29)
61420 BT	For seaming plastics; feed dog No. 61305 U, throat plate No. 61324 U-063 (adjusting screw No. 51430 F, nut No. 22840 A)

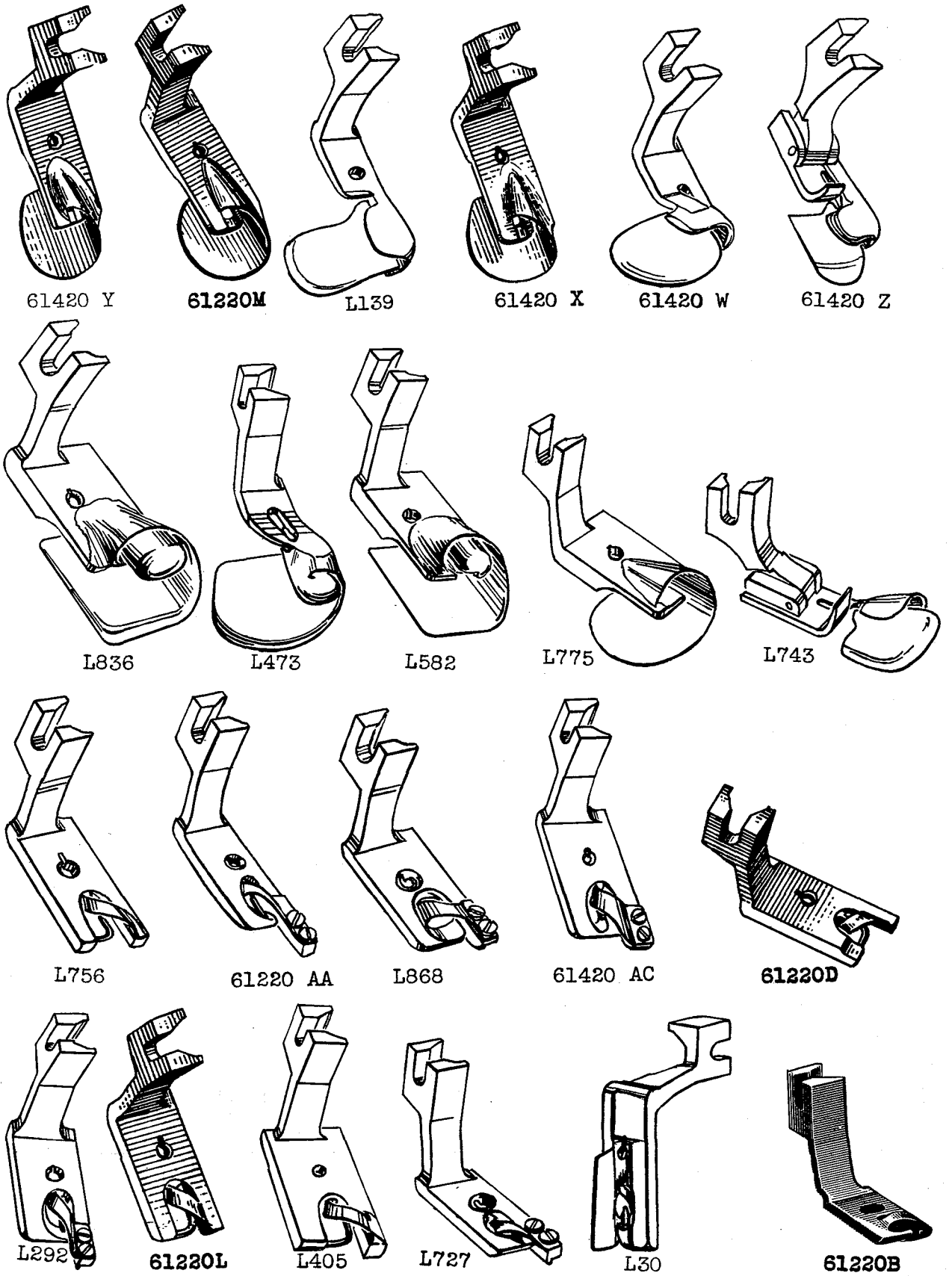

PRESSER FEET

<u>Part No.</u>	<u>Description</u>
L30	For hemming, 1/8 inch hem, has guide to fit in throat plate; feed dog No. L29, throat plate No. L28 (scroll No. L774)
L139	For miscellaneous hemming, material enters from left, 3/16 inch turned down hem, feed dog No. 61205 C, throat plate No. 61224 C-063
L292	For hemming shirts, 3/16 inch hem; feed dog No. 61405 Z, throat plate No. 61224 B-063 (scroll pin No. 61230 C, screw No. 22738)
L405	For hemming suede and light weight materials, 1/4 inch hem; feed dog No. 61205 C, throat plate No. 61224 C-063 (scroll pin No. 16230 C, scroll No. 61230-5/32)
L473	For miscellaneous hemming, 5/32 inch turned up hem; feed dog No. 61205 A, throat plate No. 61224 C-063
L582	For hemming dresses, material enters from left, 3/8 inch turned up hem; feed dog No. 61205 C, throat plate No. 61224 C-063
L727	For hemming shirts, 3/32 inch hem; feed dog No. 61405 Z, throat plate No. 61224 B-063 (scroll pin No. 61230 C, screw No. 22738)
L743	For hemming light canvas, 1/2 inch turned down hem; feed dog No. 61205 D, throat plate No. 61224 F-063 (shank No. 61330, hinge pin No. 61330 B-29)
L756	For hemming shirts, 7/32 inch hem; feed dog No. 61205 C, throat plate No. 61224 C-063 (scroll pin No. 61230 J)
L775	For miscellaneous hemming, material enters from left, 1/4 inch turned up hem; feed dog No. 61205 D, throat plate No. 61224 F
L836	For hemming dresses, material enters from left, 1/2 inch turned up hem; feed dog No. 61205 A, throat plate No. 61224 C-063
L868	For hemming shirts, 1/4 inch hem; feed dog No. 61205 C, throat plate No. 61224 C-063 (scroll pin No. 61230 C, screw No. 22738)
61220 B-1/8	For hemming shirts; feed dog No. 61205 B, throat plate No. 61224 B-063 (scroll No. 61230 B-1/8, pin No. 61230 C)
61220 B-5/32	For hemming shirts; feed dog No. 61205 B, throat plate No. 61224 B-063 (scroll No. 61230 B-1/8, pin No. 61230 C)
61220 D-1/8	For hemming shirts; feed dog No. 61405 Z, throat plate No. 61224 B-063 (scroll No. 61230-5/32, pin No. 61230 J)
61220 L-5/32	For hemming shirts; feed dog No. 61205 B, throat plate No. 61224 B-063 (scroll No. 61230-5/32, pin No. 61230 J)
61220 M-1/8	For hemming dresses; feed dog No. 61205 C, throat plate No. 61224 C-063
61220 AA-1/8	For hemming shirts; feed dog No. 61205 B, throat plate No. 61224 C-063 (scroll No. 61230 A-1/8, pin No. 61230 C, screw No. 22738)
61420 W	For setting yokes and turning down hems on dresses, shirts and similar garments, 1/32 inch margin to right of needle; feed dog No. 61205 A, throat plate No. 61224 C-063
61420 X	For miscellaneous hemming, turned up hem, light weight material; feed dog No. 61205 C, throat plate No. 61224 C-063
61420 Y	For hemming dresses, light weight material, turned up 1/16 inch hem; feed dog No. 61205 C, throat plate No. 61224 C-063
61420 Z	For setting yokes on dress shirts, pajamas, 1/4 inch turned down fold; feed dog No. 61205 C, throat plate No. 61224 C-063
61420 AC	For 3/16 inch hem on work shirts; feed dog No. 61205 C, throat plate No. 61224 C-063 (scroll No. L603, screw No. 22738)

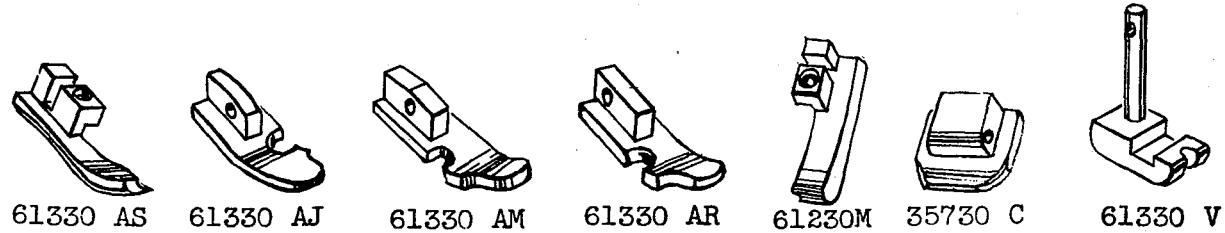
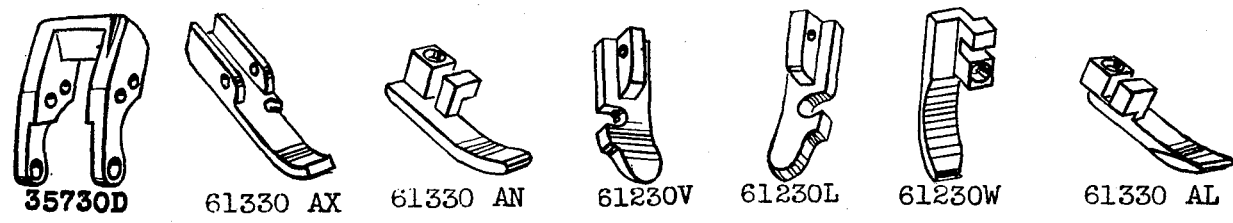
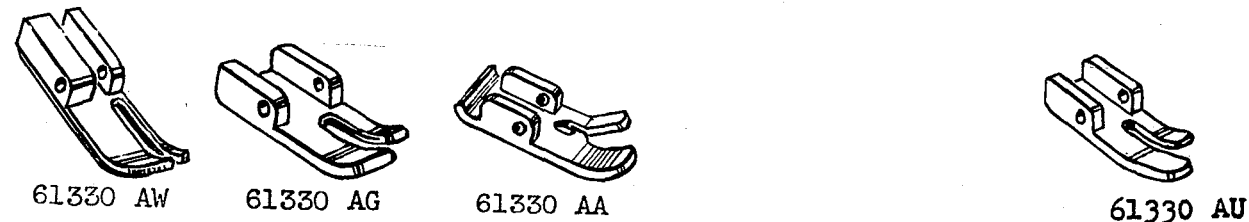
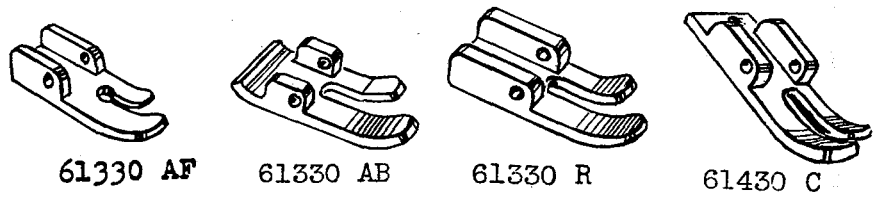
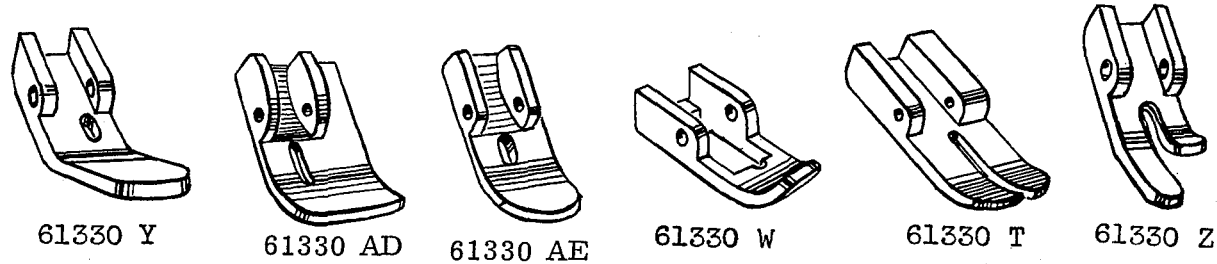
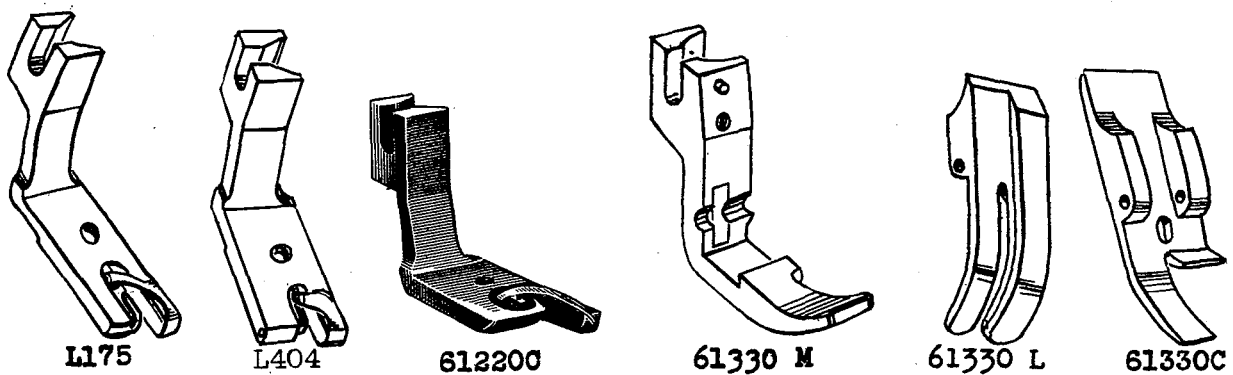

PRESSER FEET AND BOTTOMS

<u>Part No.</u>	<u>Description</u>
L175	For hemming shirts, 1/8 inch hem; feed dog No. 61205 A, throat plate No. 61224 C-063
L404	For hemming shirts, 3/32 inch hem; feed dog No. 61205 A, throat plate No. 61224 B-063
35730 C	Rear Section, for presser foot No. L556
35730 D	Yoke, for presser foot No. L556
61220 C-1/8	For hemming shirts; feed dog No. 61205 C, throat plate No. 61224 C-063 (scroll No. 61230-5/32)
61220 C-5/32	For hemming shirts; feed dog No. 61205 C, throat plate No. 61224 C-063 (scroll No. 61230-5/32)
61220 C-3/16	For hemming shirts; feed dog No. 61205 C, throat plate No. 61224 C-063 (scroll No. 61230-5/32)
61220 C-1/4	For hemming shirts; feed dog No. 61205 A, throat plate No. 61224 C-063 (scroll No. 61230-5/32)
61230 L	Bottom, for presser feet Nos. 61220 S, 61420 AN
61230 M	Yielding Section, for presser foot No. 61220 S
61230 V	Bottom, for presser foot No. 61220 W
61230 W	Yielding Section, for presser foot No. 61220 W
61330 C	Bottom, for presser foot No. 61320 C
61330 L	Bottom, for presser foot No. 61320 L
61330 M	Main Section, for presser foot No. 61320 N
61330 R	Bottom, for presser foot No. 61320 Q
61330 T	Bottom, for presser foot No. 61320 S
61330 V	Bottom Yielding Section, for presser foot No. L158
61330 W	Bottom, for presser foot No. L158
61330 Y	Bottom, for presser foot No. 61220
61330 Z	Bottom, for presser foot No. 61220 J
61330 AA	Bottom, for presser foot No. 61320 Z
61330 AB	Bottom, for presser foot No. 61320 AA
61330 AD	Bottom, for presser foot No. 61220 K
61330 AE	Bottom, for presser foot No. 61220 Q
61330 AF	Bottom, for presser foot No. 61320 R
61330 AG	Bottom, for presser foot No. 61220 P
61330 AJ	Bottom, for presser foot No. 61320 AG
61330 AL	Yielding Section, for presser foot No. 61320 AG
61330 AM	Bottom, for presser foot No. 61320 AH
61330 AN	Yielding Section, for presser foot No. 61320 AH
61330 AR	Bottom, for presser foot No. 61320 AJ
61330 AS	Yielding Section, for presser foot No. 61320 AJ
61330 AU	Bottom, for presser foot No. 61320 AD
61330 AW	Bottom, for presser foot No. 61320 AL
61330 AX	Bottom, for presser foot No. 61320 AM
61430 C	Bottom, for presser foot No. 61420 C

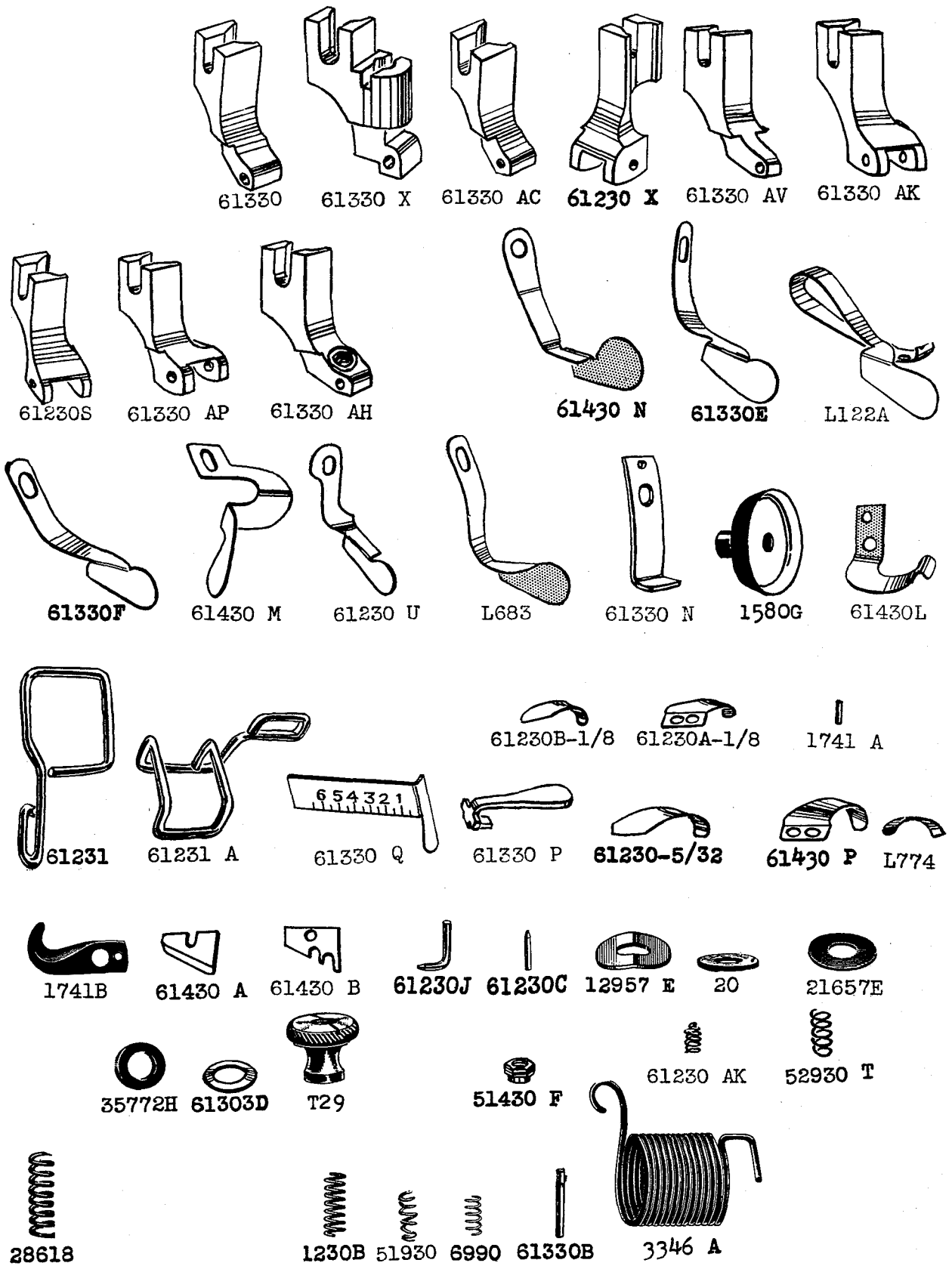

PRESSER FEET SHANK, SPRINGS AND GUIDES

<u>Part No.</u>	<u>Description</u>
20	Washer, for hemmer support Nos. K51623, K51626
T29	Thumb Nut, for edge guide assembly No. L367
L122 A	Spring Guide, for presser foot No. L653
L683	Spring Guide, for presser foot No. L336
L774	Hemmer Scroll, for presser foot No. L30
1230 B	Spring, for presser foot No. L158
1580 G	Roller, 13/16 inch diameter, 3/16 inch face, for presser foot No. 61420 BA
1741 A	Pin, for knife on presser foot No. L218
1741 B	Chain Cutting Knife, for presser foot No. L218 (screw No. 187 A)
3346 A	Lever Spring, for attachment No. L627
6990	Spring, for tilting bottom of presser foot No. L69
12957 E	Spring Washer, for plate hemmer No. L32; also Nos. L390, L394, L524, K51623
21657 E	Washer, for pivot screw on edge guide No. L367
28618	Edge Guide Locking Spring, for presser foot No. 61320 D
35772 H	Spring Washer, for swinging arm No. 23278 K
51430 F	Hinge Adjusting Screw Nut, for presser foot No. 61420 AS; also Nos. 61330 AH, 61420 BR, 61420 BT, L563, L943
51930	Spring, for tilting bottoms of presser feet
52930 T	Spring, for presser foot No. 61420 AB
61230-5/32	Hemmer Scroll, for presser feet Nos. K51697, 61220 C-1/8, -5/32, -3/16, -1/4, 61220 D-18, 61220 L-5/32
61230 A-1/8	Hemmer Scroll, for presser foot No. 61220 AA-1/8
61230 B-1/8	Hemmer Scroll, for presser foot No. 61220 B-1/8, -5/32
61230 C	Scroll Pin, for presser feet Nos. L292, 61220 B-1/8, 61220 AA-1/8
61230 J	Scroll Pin, for presser feet Nos. 61220 D-1/8, 61220 L-5/32, L756
61230 S	Shank, for presser foot No. 61220 S
61230 U	Spring Guide, for presser feet Nos. 61220 AC, 61320 U
61230 X	Shank, for presser foot No. 61220 W
61230 AK	Spring, for presser foot No. 61220 J
61231	Finger Guard, attaches to presser foot
61231 A	Finger Guard, attaches to presser foot
61303 D	Washer, for Nos. 61303, L378
61330	Shank, for presser feet Nos. 61220 P, 61320 C, 61320 L, 61320 Q, 61320 S, 61320 AA, 61420 C, 61420 AD, 61420 AP, 61420 AU, 61420 AW, 61420 B, L64, L525, L563, L566, L926
61330 B-29	Hinge Pin, 29/64 inch long
61330 B-31	Hinge Pin, 31/64 inch long
61330 B-35	Hinge Pin, 35/64 inch long
61330 B-39	Hinge Pin, 39/64 inch long
61330 E	Spring Guide, for presser feet Nos. 61320 E, 61320 V
61330 F	Spring Guide, for presser feet Nos. 61320 F, 61320 AE
61330 N	Spring, for adjustable guide on presser foot No. 61320 N
61330 P	Spring Release Lever, for presser foot No. 61320 N
61330 Q	Adjustable Guide, for presser foot No. 61320 N
61330 X	Shank, for presser foot No. 61420 AB
61330 AC	Shank, for presser feet Nos. L266, 61220 A, 61220 J, 61220 K, 61220 Q, 61320 R, 61320 AD, 61420 BD
61330 AH	Shank, for presser feet Nos. 61420 AS, 61420 D
61330 AK	Shank, for presser foot No. 61320 AG
61330 AP	Shank, for presser foot No. 61320 AH
61330 AV	Shank, for presser foot No. 61320 AL
61430 A	Knife, chain cutter for presser foot No. 61420 C
61430 B	Knife Guard, for presser foot No. 61420 C
61430 L	Spring, for roller presser foot No. 61420 BA
61430 M	Spring Guide, for presser foot No. 61420 K
61420 N	Spring Guide, for presser foot No. 61420 L
61430 P	Scroll, for presser foot No. 61420 AC (screw No. 22738)

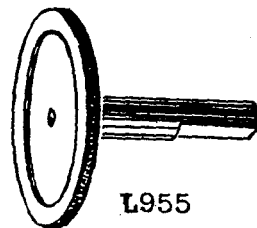
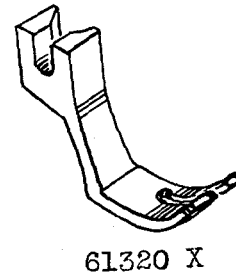
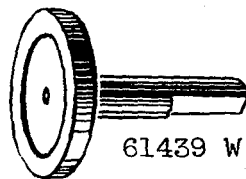
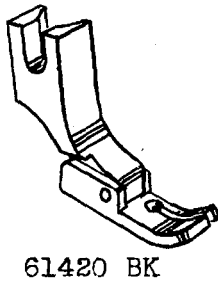
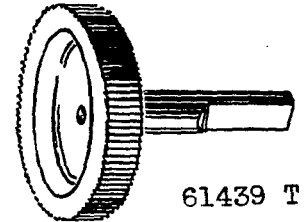
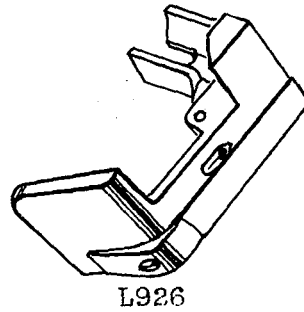
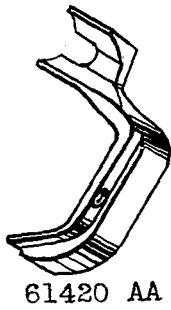
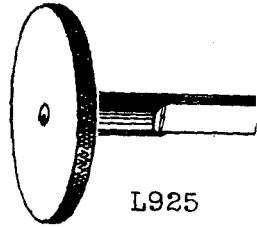
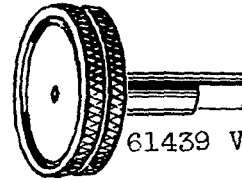
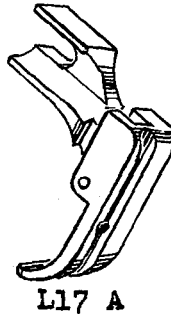
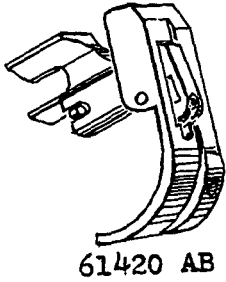
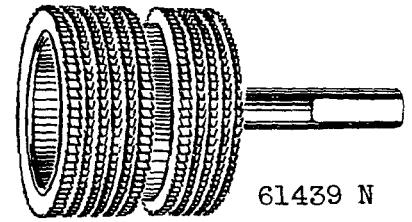
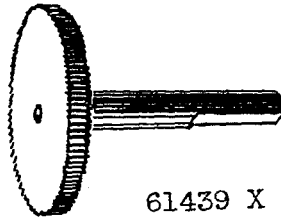
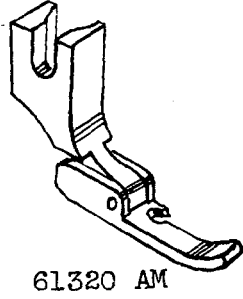
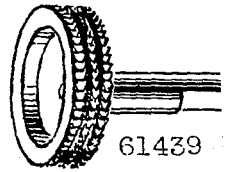
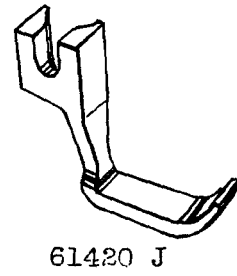
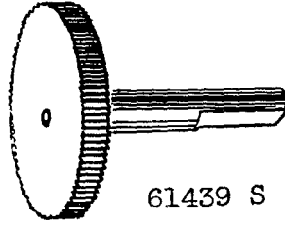
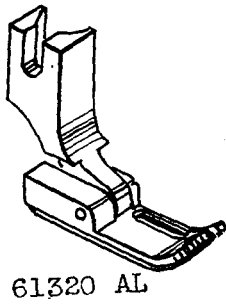

PRESSER FEET AND TOP FEED ROLLERS
FOR STYLES 61400 N, 61400 P, 61400 R, 61400 S

<u>Part No.</u>	<u>Description</u>
L17 A	For piping pillow slips; foot has 1/16 inch groove to left of needle; feed dog No. 61405 F, throat plate No. 61424 F, top feed No. 61439 V (hinge pin No. 61330 B-29)
L39 A	For seaming on two or more plies material; feed dog No. 61305 T, throat plate No. 61324 R, top feed No. 61439 S (hinge pin No. 61330 B-29, spring No. 51930)
L925	For sleeve facing and hemming bottom of sport shirts, width of roller .2031, diameter of roller 1 15/64 inches; feed dog Nos. 61205 C, 61405 B, throat plate Nos. 61224 C, 61424 B, presser feet Nos. 61420 AB, 61420 BK
L926	For sleeve facing, hemming sport and woolen shirts; feed dog Nos. 61405 G, 61305 K, throat plate Nos. 61424 G, 61324 J, top feed No. 61439 T (bottom No. 61330, hinge screw No. 22799 B, toe guide No. 51230 P, screw No. 605)
L955	For top stitching waistbands to work pants, width of roller .070 inch, diameter of roller 1 15/64 inches; feed dog No. 61405 G, throat plate No. 61424 G, presser foot No. 61320 X
61320 X	For top stitching waistbands to work pants; feed dog No. 61405 G, throat plate No. 61424 G, top feed No. L955
61320 AL	For miscellaneous seaming on heavy material; feed dog Nos. 61205 A, 61305 T, throat plate Nos. 61224 C, 61324 R, top feed Nos. 61439 S, 61439 X (shank No. 61330 AV, bottom No. 61330 AW, hinge pin No. 61330 B-29)
61320 AM	For attaching collar bands to dress shirts; feed dog No. 61205 C, throat plate No. 61224 C, top feed No. 61439 X (shank No. 61330 AX, bottom No. 61330 AV, hinge pin No. 61330 B-29)
61420 J	For top stitching waistbands to work pants; feed dog No. 61305 A, throat plate No. 61324 A, top feed No. 61439 U
61420 AA	For attaching sleeve facings on shirts and sewing cord to pockets of work and dress pants; feed dog Nos. 61205 A, 61205 C, 61405 B, throat plate Nos. 61224 C, 61424 B, top feed Nos. 61439 N, 61439 S, 61439 T
61420 AB	For sleeve facing and hemming shirts, jackets, and children's garments; feed dog Nos. 61405 B, 61405 S, throat plate Nos. 61424 B, 61424 S, top feed Nos. 61439 T, 61439 V, L925 (bottom yielding section No. 61430 BA, shank No. 61330 X, yielding section spring No. 52930 T, hinge pin No. 61330 B-29)
61420 BK	For attaching waistbands, hemming trousers, and sewing zippers to rayon material; feed dog Nos. 61205 C, 61405 A, 61405 E, throat plate Nos. 61424, 61424 A, 61424 E, top feed Nos. 61439 S, 61439 W, L925 (hinge pin No. 61330 B-29)
61439 N	For attaching sleeve facings to work and dress shirts, width of roller 1 inch, diameter of roller 1.232 inches; feed dog No. 61205 C, throat plate No. 61224 C-063, presser foot No. 61420 AA
61439 S	For sewing on waistbands and seaming on heavy material, width of roller .156 inch, diameter of roller 1 15/64 inches; feed dog Nos. 61205 A, 61405 E, 61305 T, throat plate Nos. 61224 C, 61324 R, 61424 E, presser foot Nos. 61320 AL, 61420 AA, 61420 BK, L39 A
61439 T	For sleeve facing and hemming sport and heavy woolen shirts, width of roller .250 inch, diameter of roller 1 15/64 inches; feed dog Nos. 61305 K, 61405 B, 61405 G, throat plate Nos. 61324 J, 61424 B, 61424 G, presser feet Nos. 61420 AA, L926
61439 U	For stitching waistbands to work pants, width of roller .250 inch, diameter of roller 1 inch; feed dog No. 61305 A, throat plate No. 61324 A, presser foot No. 61420 J
61439 V	For piping pillow slips, facing children's garments and jackets, width of roller .280 inch, diameter of roller 1 inch; feed dog Nos. 61405 F, 61405 V, throat plate Nos. 61424 B, 61424 F, presser feet Nos. 61420 AB, L17 A
61430 W	For top stitching zippers to rayon, rubberized roller; width of roller .132 inch, diameter of roller 1 inch; feed dog No. 61405 A, throat plate No. 61424 A, presser foot No. 61420 BK
61439 X	For attaching collar bands to work and dress shirts; width of roller .125 inch, diameter of roller 1 15/64 inches; feed dog No. 61205 C, throat plate No. 61224 C, presser foot No. 61320 AM

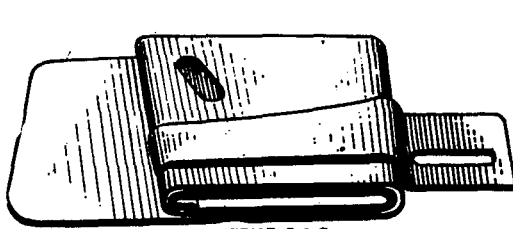

K51689

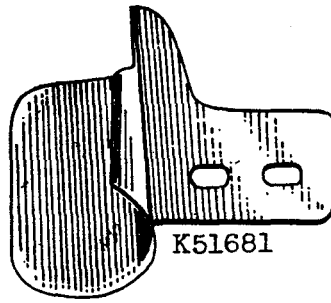

K51681

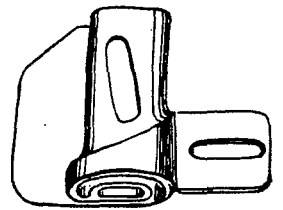

K51621

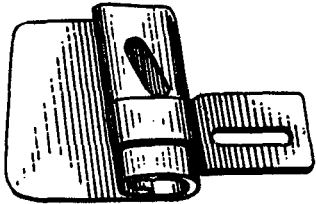

K51688

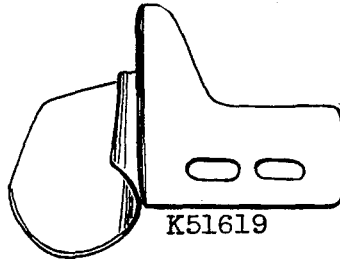

K51619

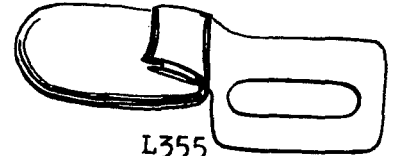

L355

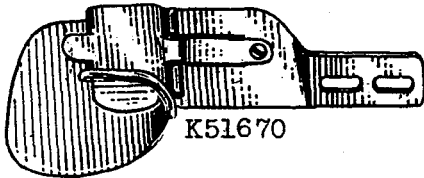

K51670

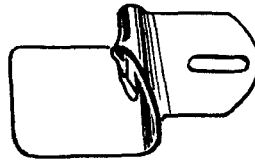

L327

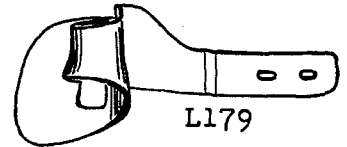

L179

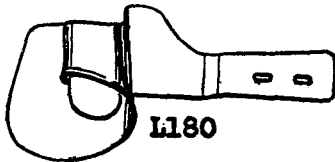

L180

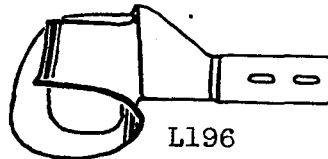

L196

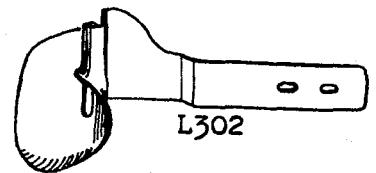

L302

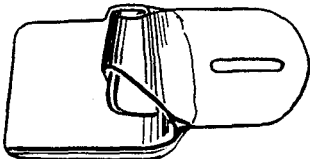

L564

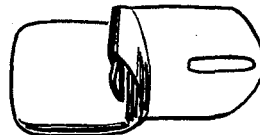

23510-1/4-5/64

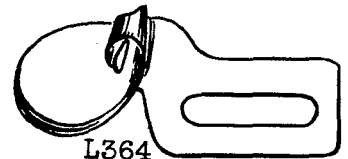

L364

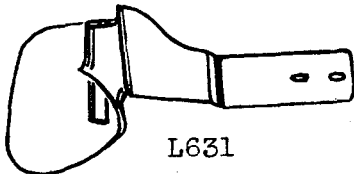

L631



L378

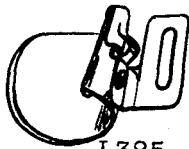

L385



L516



L394

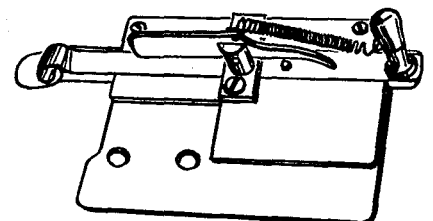

L96

HEMMERS

<u>Part No.</u>	<u>Description</u>
L96	For hemming shirt tails, has retractable scroll, for 3/16 inch hem, feed dog No. 61205 CA, throat plate No. 61224 C-063, presser foot No. L95 (attaching screw No. 25 C, locking lever screw No. 22585, gib screw No. 90)
L179	For hemming upholstery, 1/16 inch capacity, hem turned up, with underlap of 7/16 inch, finishes 1 inch, attached to swinging bracket No. K51623; feed dog No. 61205 A, throat plate No. 61224 C-073, presser foot No. 61220 T (screw No. 22570)
L180	For hemming drapery material, 3/32 inch capacity, finishes 1 1/2 inches, attached to swinging bracket No. K51623; feed dog No. 61205 A, throat plate No. 61224 C-063, presser foot No. 61220 T (screw No. 22570)
L196	For hemming drapery material, attached to swing-out bracket No. K51623, finishes 2 inches, 7/16 inch underlap; feed dog No. 61205 A, throat plate No. 61224 C-063, presser foot No. 61420 H (screw No. 22570)
L302	For hemming drapery material, hem turned up with 5/16 inch underlap, finishes 1/2 inch, attached to swinging bracket No. K51623; feed dog No. 61205 A, throat plate No. 61224 C-073, presser foot No. 61220 T (screw No. 22570)
L327	For hemming button facings on work shirts, 3/32 inch capacity, 1/2 inch finish, attached to swing-out bracket No. 23278 K; feed dog No. 61305 A, throat plate No. 61324 A-093, presser foot No. 61320 AH (screw No. 22585 A)
L355	For hemming chambray work shirts, finishes 11/16 inch; feed dog No. 61205 A, throat plate No. 61224 C-063, presser foot No. 61420 BN (screw No. 25 C)
L364	Miscellaneous hemming operations on light weight material, capacity 1/16 inch, finishes 3/8 inch; feed dog No. 61205 C, throat plate No. 61224 C-063, presser foot No. 61320 AJ (screw No. 25 C)
L378	For hemming shirts, 5/64 inch capacity, finishes 5/16 inch, swing-out type; feed dog No. 61205, throat plate No. 61224, presser foot No. 61420 BN (attaching screw No. 94, hemmer No. L385, hemmer attaching screw No. 90, thumb screw No. 22551, swinging bracket No. 61303 B, pivot screw No. 154, washer No. 61303 D)
L385	For hemming shirts, 5/64 inch capacity, finishes 5/16 inch
L394	For hemming high back overalls, 1/8 inch capacity, finishes 3/8 inch, swing-out type; feed dog No. 61305 A, throat plate No. 61324 A-093, presser foot No. 61320 L (attaching screw No. 25 C, pivot screw No. 22726, washer No. 12957 E)
L516	For hemming rayon and cotton materials, capacity 1/16 inch, finishes 1/4 inch, attached to swing-out bracket No. K51623; feed dog No. 61205 C, throat plate No. 61224 C-063, presser foot No. 61420 AR (screw No. 22570)
L564	For finishing button stays on medium weight sport shirts, 5/64 inch capacity, finishes 5/8 inch hem, attached to swing-out bracket No. 23278 K; feed dog No. 61205 A, throat plate No. 61224 C-063, presser foot No. 61220 W (screw No. 22585 A)
L631	For hemming drapery material, 1/4 inch underlap, attached to swing-out bracket No. K51623, finishes 3/4 inch; feed dog No. 61205 A, throat plate No. 61224 C-073, presser foot No. 61220 Q (screw No. 22570)
23510-1/4-5/64	For hemming button stays on work shirts, 5/64 inch capacity, finishes 1/4 inch, attached to swinging bracket No. K51623; feed dog No. 61205 A, throat plate No. 61224 C-063, presser foot No. 61220 W (screw No. 22585 A)
K51619	For hemming towels, 1/16 inch capacity, finishes 1/4 inch; feed dog No. 61205 A, throat plate No. 61224 C-063, presser foot No. 61220 T (screw No. 25 C)
K51621	For hemming bed sheets, 1/16 inch capacity, finishes 1 inch, attached to swing-out bracket No. K51659; feed dog No. 61205 A, throat plate No. 61224 C-063, presser foot No. 61420 BG (screw No. 22711)
K51670	For hemming house dresses, 5/64 inch capacity, finishes 1 1/2 inches, attached to swing-out bracket No. K51623; feed dog No. 61205, throat plate No. 61224, presser foot No. 61220 (screw No. 22570)
K51681	For hemming towels, 5/16 inch capacity, finishes 3/32 inch; feed dog No. 61205 A, throat plate No. 61224 C-063, presser foot No. 61220 T (screw No. 25 C)
K51688	For hemming bed sheets, with 3/8 inch underlap, finishes 1 inch, 1/16 inch capacity, attached to swing-out bracket No. K51659; feed dog No. 61205 A, throat plate No. 61224 C-063, presser foot No. 61420 BG (screw No. 22711)
K51689	For hemming bed sheets, with 3/8 inch underlap, 1/16 inch capacity, finishes 3 inches, attached to swing-out bracket No. K51659; feed dog No. 61205 A, throat plate No. 61224 C-063, presser foot No. 61420 BG (screw No. 22711)

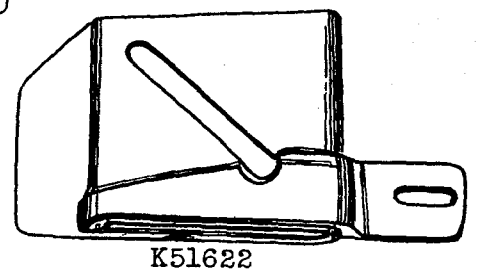
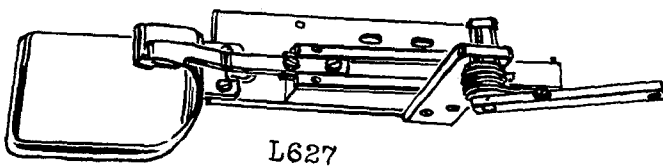
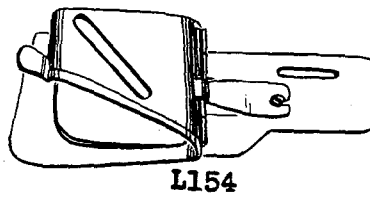
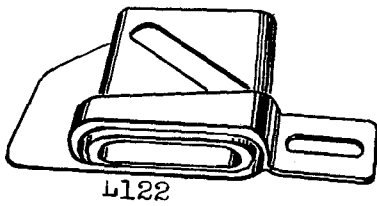
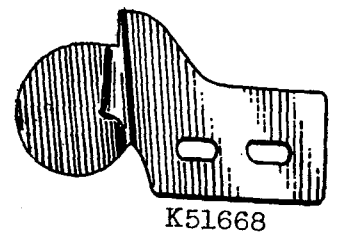
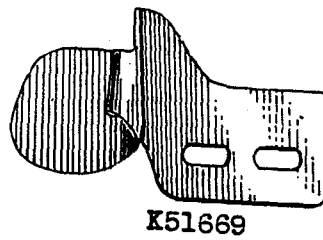
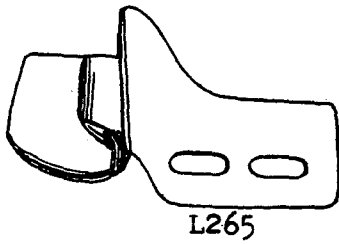
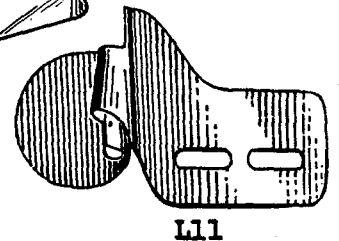
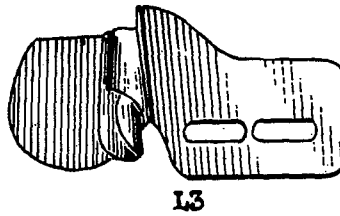
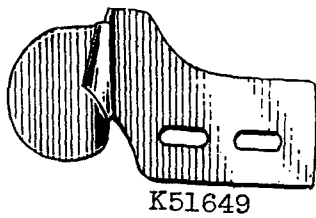
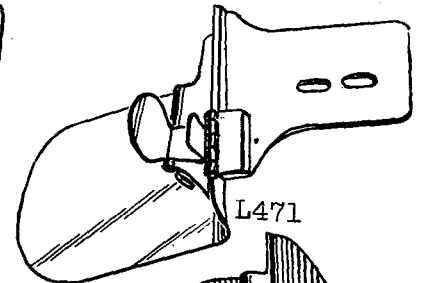
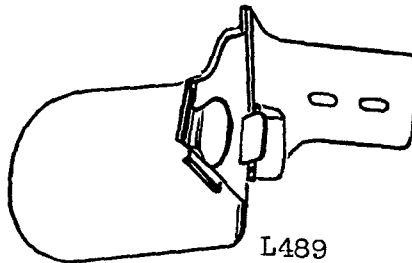
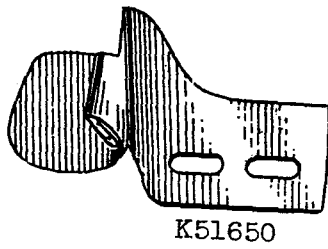
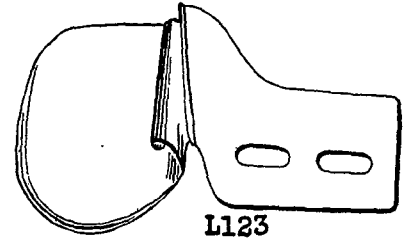
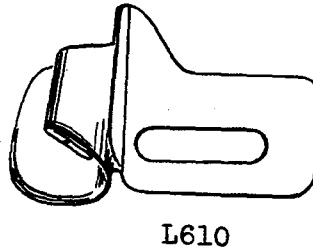
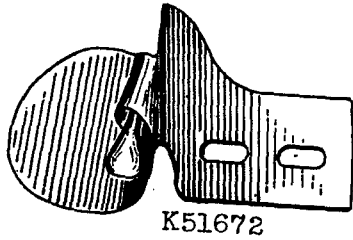
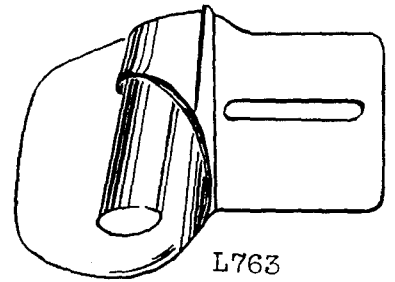
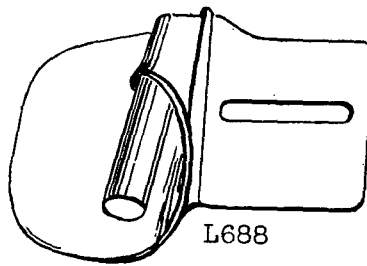
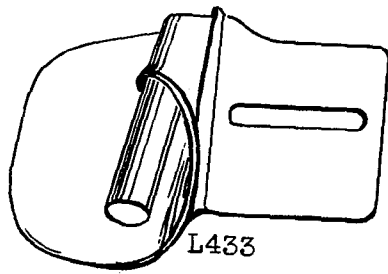

HEMMERS

<u>Part No.</u>	<u>Description</u>
L3	For hemming overall suspender straps, 1/16 inch capacity, finishes 5/16 inch; feed dog No. 61305 C, throat plate No. 61324 C-093, presser foot No. 61320 L (screw No. 25 C)
L11	For hemming rayon and similar materials, 3/64 inch capacity, finishes 5/16 inch; feed dog No. 61205 A, throat plate No. 61224 C-063, presser foot No. 61220 J (screw No. 25 C)
L122	For hemming bed sheets, 1/16 inch capacity, finishes 2 inches, attached to swing-out bracket No. K51659; feed dog No. 61205 C, throat plate No. 61224 C-063, presser foot No. 61420 BG (screw No. 22711)
L123	Plate Hemmer, for garments made of muslin, 1/16 inch capacity, finishes 1/8 inch; feed dog No. 61205 C, throat plate No. 61224 C-063, presser foot No. 61220 J (screw No. 25 C)
L154	For hemming mesh curtains, 3/32 inch capacity, finishes 3 1/4 inches, attached to swing-out bracket No. K51623; feed dog No. 61205 C, throat plate No. 61224 C-063, presser foot No. 61220 (screw No. 22570)
L265	For hemming men's shorts, 5/64 inch capacity, finishes 1/2 inch; feed dog No. 61205 C, throat plate No. 61224 C-063, presser foot No. 61420 BN (screw No. 25 C)
L433	For miscellaneous hemming operations, 3/32 inch capacity, finishes 11/16 inch; feed dog No. 61305 D, throat plate No. 61324 D-093, presser foot No. 61420 S (screw No. 25 C)
L471	For hemming sleeves and work shirts, finishes 1/2 inch; feed dog No. 61205 A, throat plate No. 61224 C-063, presser foot No. 61320 AJ (screw No. 22585 A)
L489	For hemming sleeves and bottom of sport shirts, finishes 3/4 inch; feed dog No. 61205 A, throat plate No. 61224 C-063, presser foot No. 61220 (screw No. 22585 A)
L610	For hemming men's shorts, finishes 3/4 inch; feed dog No. 61205 C, throat plate No. 61224 C-063, presser foot No. 61220 (screw No. 25 C)
L627	For hemming denim material, attached to swing-out bracket No. K51623, finishes 1 3/8 inches; feed dog No. 61305 A, throat plate No. 61324 A-093, presser foot No. 61420 BN (screw No. 22585 A)
L688	For miscellaneous hemming operations, capacity 1/16 inch, finishes 5/8 inch, 1/4 inch underlap; feed dog No. 61205 A, throat plate No. 61224 C-063, presser foot No. L505 (screw No. 25 C)
L763	For hemming herringbone and twill, 1/16 inch capacity, finishes 7/8 inch, 1/4 inch underlap; feed dog No. 61305 A, throat plate No. 61324 A-093, presser foot No. 61420 H (screw No. 25 C)
K51622	For hemming bed sheets, 1/16 inch capacity, finishes 3 inches, attached to swing-out bracket No. K51659; feed dog No. 61205 A, throat plate No. 61224 C-063, presser foot No. 61420 BG (screw No. 22711)
K51649	For hemming muslin garments, 3/64 inch capacity, finishes 1/8 inch; feed dog No. 61205 A, throat plate No. 61224 C-063, presser foot No. 61220 T (screw No. 25 C)
K51650	For hemming men's woven shorts, 5/64 inch capacity, finishes 3/8 inch; feed dog No. 61205 C, throat plate No. 61224 C-063, presser foot No. 61220 T (screw No. 25 C)
K51668	For hemming muslin garments, capacity 5/64 inch, finishes 3/16 inch; feed dog No. 61205 C, throat plate No. 61224 C-063, presser foot No. 61220 T (screw No. 25 C)
K51669	For hemming men's woven shorts, 5/64 inch capacity, finishes 1/4 inch; feed dog No. 61205 C, throat plate No. 61224 C-063, presser foot No. 61220 (screw No. 25 C)
K51672	For hemming overall suspender straps, 5/64 inch capacity, finishes 5/16 inch; feed dog No. 61305 C, throat plate No. 61324 C-093, presser foot No. 61320 C (screw No. 25 C)

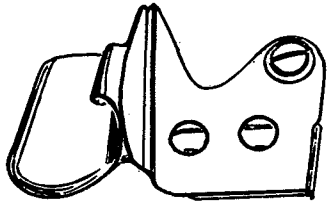

L524

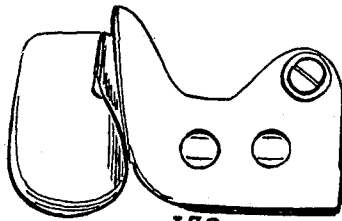

L32

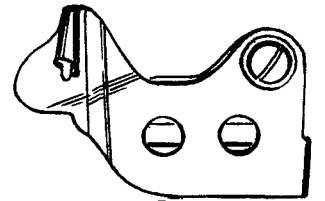

L390

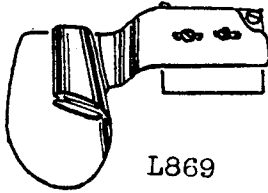

L869

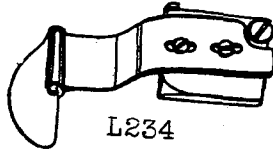

L234

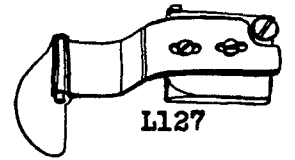

L127



L719

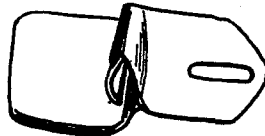

L599

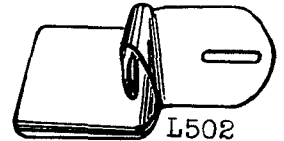

L502

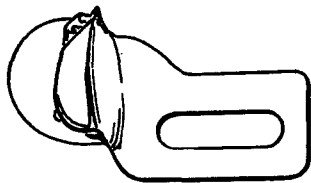

L531

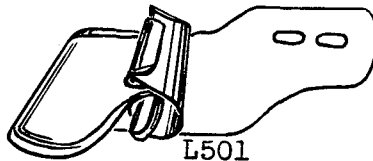

L501

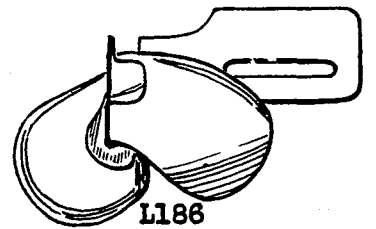

L186

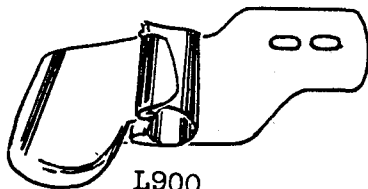

L900

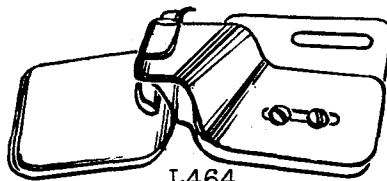

L464

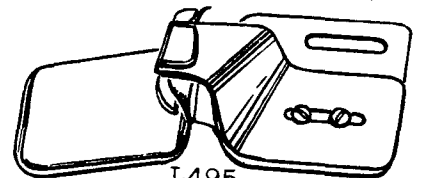

L495

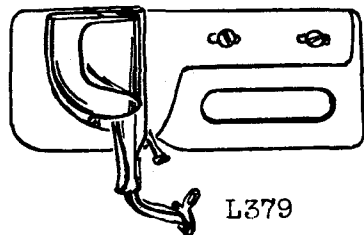

L379

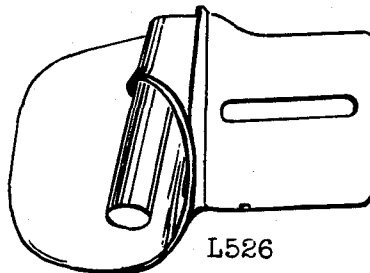

L526

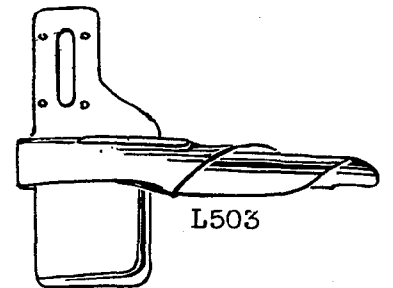

L503

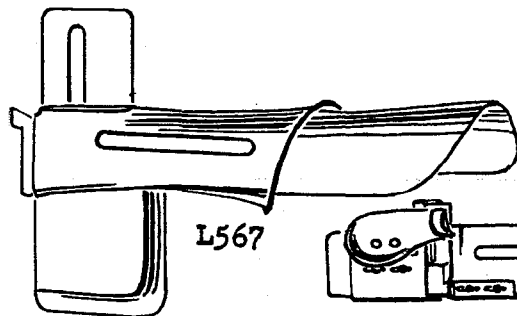

L567

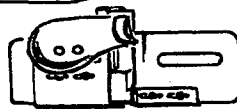

L829

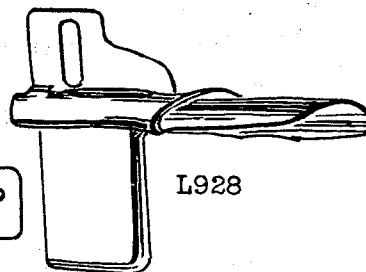

L928

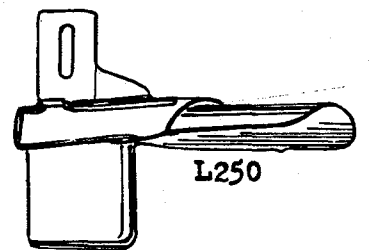

L250

HEMMERS AND FOLDERS

<u>Part No.</u>	<u>Description</u>
L32	Hemming heavy work shirts, swing-out type, finishes 3/16 inch; feed dog No. 61205 A, throat plate No. 61224 C-063, presser foot No. 61220 (attaching screw No. 25 C, pivot screw No. 22726, washer No. 12957 E)
L127	Hemming work shirts, 3/64 inch capacity, finishes 1/4 inch, swing-out type; feed dog No. 61205 C, throat plate No. 61224 C-063, presser foot No. 61420 AV (attaching screw No. 25 C, pivot screw No. 22760 A, scroll screw No. 22561)
L186	Folder and Guide, capacity 3/64 inch, finishes 3/16 inch, lower ply turned upwardly, upper ply enters from right; feed dog No. 61205 A, throat plate No. 61224 C-063, presser foot No. 61220 Q (screw No. 25 C)
L234	For hemming work shirts, swing-out type, finishes 5/16 inch; feed dog No. 61205 C, throat plate No. 61224 C-063, presser foot No. 61420 AV (attaching screw No. 25 C, scroll screw No. 22561, pivot screw No. 22760 A)
L250	Folder, for attaching sleeve facings, light weight material, 1/32 inch capacity, 2-5/8 inch width of strip, finishes 1-1/8 inches, feed dog No. 61405 K, throat plate No. 61424 K, presser foot No. 61420 H (screw No. 25 C)
L379	Folder, for cording and piping pajama coats, use 5/8 inch, bias cut tape and 3/32 inch cord; feed dog No. 61305 B, throat plate No. 61324 B-063, presser foot No. L380 (screw No. 25 C)
L390	For hemming handkerchiefs, swing-out type, 3/64 inch capacity, finishes 3/32 inch; feed dog No. L369, throat plate No. L391, presser foot No. 61320 AJ (attaching screw No. 25 C) (pivot screw No. 22726, washer No. 12957 E)
L464	Folder and Guide, making pants flies on heavy material, lower ply turned upwardly, top ply enters from right, 1/16 inch capacity; feed dog No. 61305 Q, throat plate No. 61324 Q-063, presser foot No. 61220 (attaching screw No. 22585 A, guide screw No. 22825)
L495	Folder and Guide, making pants flies on medium weight materials, 1/32 inch capacity, lower ply turned upwardly, top ply enters from right; feed dog No. 61305 Q, throat plate No. 61324 Q-063, presser foot No. 61220 (attaching screw No. 22585 A, guide screw No. 22825)
L501	Double Edge Folder, for joining shoulder seams on shirts, capacity 3/64 inch; feed dog No. 61205 C, throat plate No. 61224 C-063, presser foot No. L506 (screw No. 22585 A)
L502	Hemming overall suspender straps, capacity 5/64 inch, finishes 5/16 inch, attached to swing-out bracket No. 23278 K; feed dog No. 61305 A, throat plate No. 61324 A-093, presser foot No. 61320 L (screw No. 22585 A)
L503	Folder, for gabardine and light weight flannel sport shirts, 3/64 inch capacity, 2-5/8 inches width of strip, finishes 1-1/8 inches; feed dog No. 61405 K, throat plate No. 61424 K, presser foot No. 61420 H (screw No. 25 C)
L524	For hemming shirts and similar garments, swing-out type, finishes 3/8 inch; feed dog No. 61205 D, throat plate No. 61224 F, presser foot No. L525 (attaching screw No. 25 C, pivot screw No. 22726, washer No. 12957 E)
L526	Folder, for light weight army cloth, 1/32 inch capacity, finishes 11/16 inch; feed dog No. 61305 D, throat plate No. 61324 D-093, presser foot No. 61420 S (screw No. 25 C)
L531	Double Edge Folder, for broadcloth, 1/32 inch capacity; feed dog No. 61205 A, throat plate No. 61224 C-063, presser foot No. 61220 (screw No. 25 C)
L567	Folder, for attaching pajama cuffs, 5/16 inch margin to left of needle, 1/32 inch capacity, 5 inch width of strip, finishes 2-1/4 inches; feed dog No. 61405 K, throat plate No. 61424 K, presser foot No. L566 (screw No. 25 C)
L599	Finishing button stays, work shirts, 5/64 inch capacity, finishes 3/16 inch hem, attached to swinging bracket No. 23278 K; feed dog No. 61205 A, throat plate No. 61224 C-063, presser foot No. 61320 AJ (screw No. 22585 A)
L719	For hemming pajama pants, finishes 1-1/8 inches; feed dog No. 61205 A, throat plate No. 61224 C-063, presser foot No. 61220 (screw No. 25 C)
L829	Folder, for attaching rick-rack to house dresses, 1/16 inch capacity, 1/4 inch fold; feed dog No. 61205 A, throat plate No. 61224 C-063, presser foot No. 61220 Q (screw No. 25 C)
L869	For hemming herringbone twill, attached to swing-out bracket, finishes 5/8 inch; feed dog No. 61205 A, throat plate No. 61224 C-063, presser foot No. 61420 T (attaching screw No. 25 C, scroll screw No. 22561, pivot screw No. 22760 A)
L900	For joining shoulder seams, has 5/16 inch underlap, 3/64 capacity; feed dog No. 61205 C, throat plate No. 61224 C-063, presser foot No. L506 (screw No. 22585 A)
L928	Folder, for attaching 7/8 inch flannel sleeve facings, width of strips 2-1/4 inches, 1/4 inch underlap, 3/32 inch capacity; feed dog No. 61305 K, throat plate No. 61324 F-093, presser foot No. L926 (screw No. 25 C)

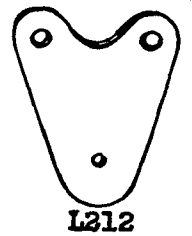
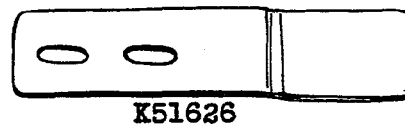
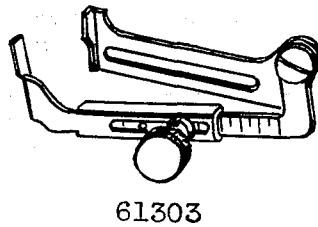
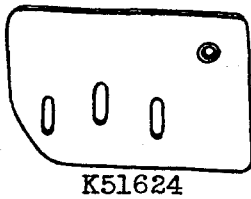
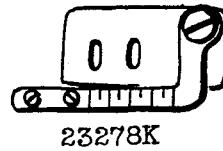
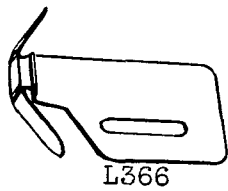
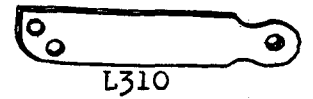
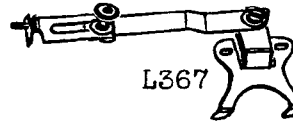
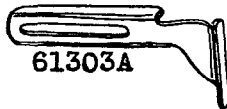
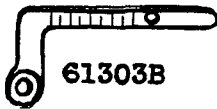
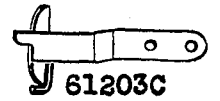
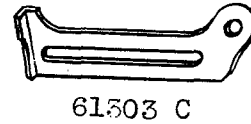
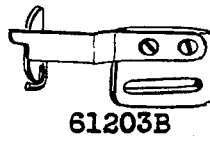
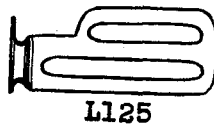
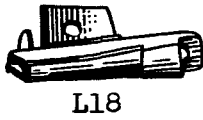
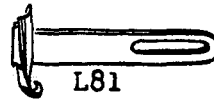
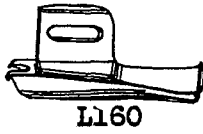
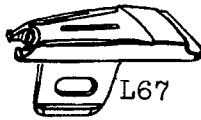
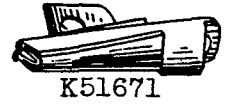
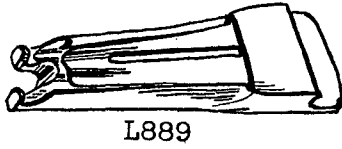
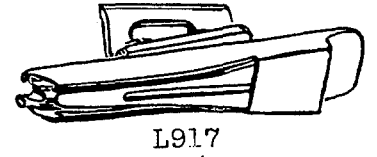
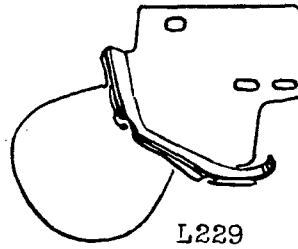
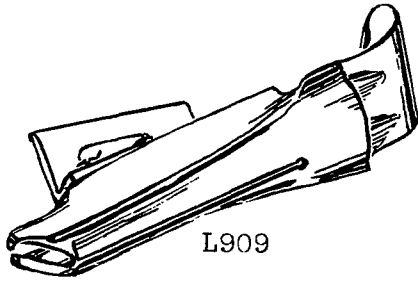

BINDERS, GUIDES, MISCELLANEOUS PARTS

<u>Part No.</u>	<u>Description</u>
L18	Cut Edge Binder, for 3/16 inch bias binding for heavy woolens; feed dog No. 61305 B, throat plate No. 61224 D-093, presser foot No. 61220 H (screw No. 22649 F-16)
L67	Cut Edge Binder, for 1 inch bias binding for melton, 3/64 inch capacity; feed dog No. 61305 B, throat plate No. 61224 D-093, presser foot No. 61220 H (screw No. 22649 F-16)
L77	Selvage Edge Binder, for 5/8 inch binding on mattress ticks, 3/64 inch capacity; feed dog No. 61305 B, throat plate No. 61224 D-093, presser foot No. 61220 H (screw No. 22649 F-16)
L81	Selvage Edge Binder, for binding on mattress ticks; feed dog No. 61305 B, throat plate No. 61224 D-093, presser foot No. 61220 H (screw No. 22585 A)
L89	Selvage Edge Binder, 5/32 inch jaw capacity; feed dog No. 61305 B, throat plate No. 61224 D-093, presser foot No. 61220 H (screw No. 22649 F-16)
L125	Edge Guide, 7/8 inch guide surface (screw No. 22585 A)
L160	Selvage Edge Binder, for 11/16 inch width ornamental binding on mattress ticks, 1/16 inch capacity; feed dog No. 61305 B, throat plate No. 61324 D-093, presser foot No. 61220 H (screw No. 22649 F-16)
L184	Selvage Edge Binder, for light weight material, 1/32 inch capacity, finishes 1/2 inch; feed dog No. 61305 B, throat plate No. 61324 B-093, presser foot No. 61220 H (screw No. 22649 F-16)
L212	Base, for swinging bracket No. K51659 (screw No. 94)
L229	Cut Edge Binder, for pocket facings, 11/16 inch bias cut strip; feed dog No. 61305 B, throat plate No. 61324 B-093, presser foot No. 61220 H (screw No. 22649 F-16)
L289	Selvage Edge Binder, for 11/16 inch binding; feed dog No. 61305 B, throat plate No. 61324 B-093, presser foot No. 61220 H (screw No. 22649 F-16)
L310	Binder Swinging Arm Adapter Bracket, for special binders
L366	Edge Guide, for stitching cuffs to shirts (screw No. 22585 A)
L367	Adjustable Throw-out Edge Guide, for stitching down collars (attaching screw No. 94, pivot screw No. 22726, washer No. 12957 E, thumb nut No. T29, washer No. 21657 E)
L377	Edge Guide, for use with plate hemmer No. L378 (screw No. 22585 A)
L766	Selvage Edge Binder, for 9/16 inch binding, 5/32 inch jaw capacity; feed dog No. 61305 B, throat plate No. 61224 D-093, presser foot No. 61220 H (screw No. 22649 F-16)
L889	Cut Edge Binder, for binding coat seams, 5/8 inch bias cut strips; feed dog No. 61205 B, throat plate No. 61224 B-093, presser foot No. L235
L909	Cut Edge Binder, for broadcloth shirts, 1/32 inch capacity, bias cut strips 1 1/8 inches, finishes 13/32 inch; feed dog No. 61305 B, throat plate No. 61224 D-063, presser foot No. 61220 H (screw No. 22649 F-16)
L917	Cut Edge Binder, for silk and similar materials, 1/2 inch bias cut strips, 1/8 inch finish; feed dog No. L916, throat plate No. 61224 D-063, presser foot No. 61220 H (screw No. 22649 F-16)
23278 K	Swing-out Bracket, for small plate hemmers (attaching screw No. 22585 A, pivot screw No. 22726, washer No. 35772 H)
K51624	Base, for Nos. K51606, K51623 (screw No. 94)
K51626	Hemmer Support, for No. K51606 (screw No. 22570, washer No. 20)
K51655	Cut Edge Binder, for 1 inch bias binding, 3/64 inch capacity; feed dog No. 61305 B, throat plate No. 61224 D-093, presser foot No. 61220 (screw No. 22649 F-16)
K51666	Cut Edge Binder, for 3/4 inch bias binding, 3/64 inch capacity; feed dog No. 61305 B, throat plate No. 61224 D-093, presser foot No. 61220 H (screw No. 22649 F-16)
K51667	Cut Edge Binder, for 7/8 inch bias binding; feed dog No. 61305 B, throat plate No. 61224 D-093, presser foot No. 61220 H (screw No. 22649 F-16)
K51671	Cut Edge Binder, for 1 inch bias binding, 1/16 inch capacity; feed dog No. 61305 B, throat plate No. 61224 D-093, presser foot No. 61220 H (screw No. 22649 F-16)
K51677	Selvage Edge Binder, for 5/8 inch bias binding, 1/32 inch capacity; feed dog No. 61305 B, throat plate No. 61224 D-093, presser foot No. 61220 H (screw No. 22649 F-16)
K51699	Cut Edge Binder, for 5/8 inch straight cut binding, 3/64 inch capacity; feed dog No. 61305 B, throat plate No. 61224 D-093, presser foot No. 61220 H (screw No. 22649 F-16)
61203 B	Flexible Guide Assembly, for edge stitching collars and cuffs on dress shirts; one each Nos. 61203 C, 61203 D; two No. 22561 (screw No. 22585 A)
61203 C	Flexible Edge Guide, for No. 61203 B (screw No. 22561)
61203 D	Base, for No. 61203 B
61303	Adjustable Edge Guide, swing-out type, for edge stitching coats and vests; one each Nos. 134, 22551, 61303 A, 61303 B, 61303 C, 61303 D (screw No. 22585 A)
61303 A	Edge Guide, for No. 61303 (screw No. 22551)
61303 B	Edge Guide Holder, for No. 61303, also for Nos. 23278 K, L378
61303 C	Edge Guide Holder Base, for No. 61303

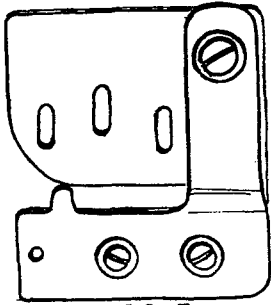

K51623

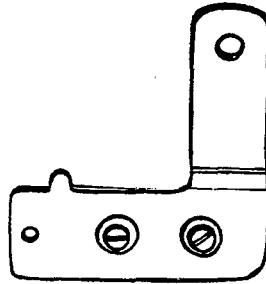

K51625

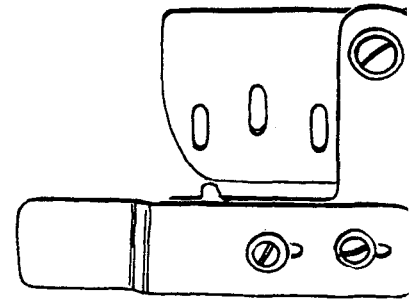

K51606

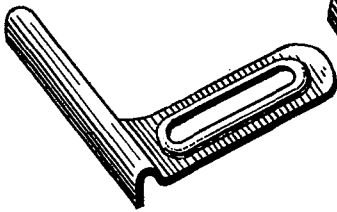

61203

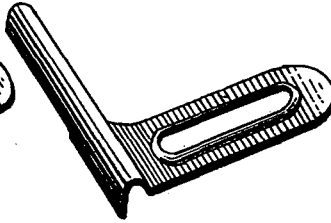

61203A



61303 E

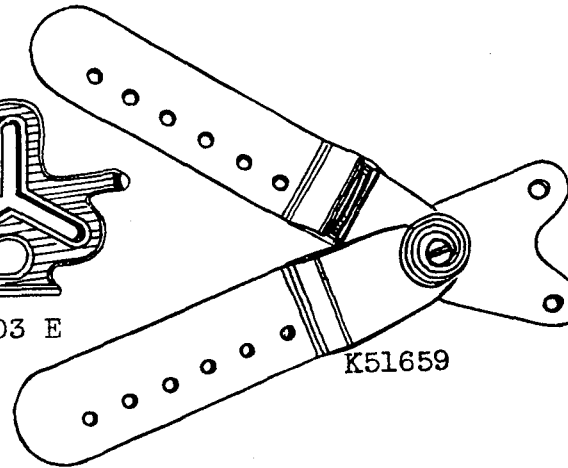

K51659

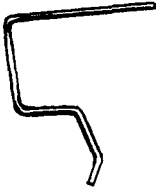

23133 F

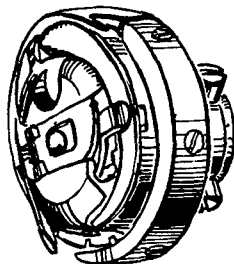

L628

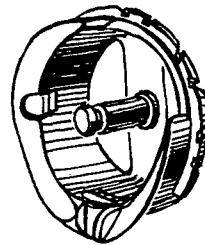

L629

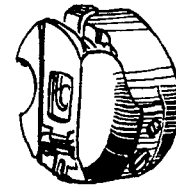

61413 E

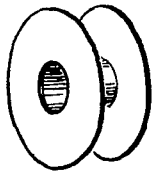

61212

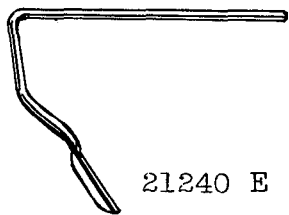

21240 E

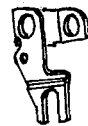

21240 B



660-215

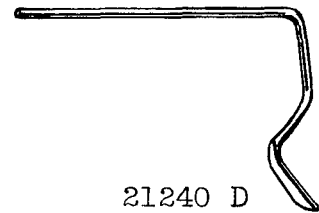

21240 D

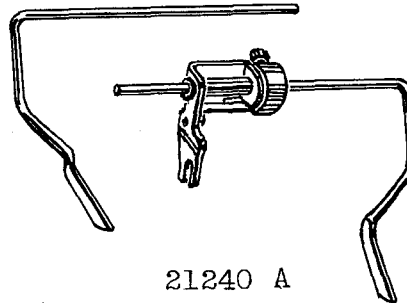

21240 A



21240 F



21240 C

MISCELLANEOUS PARTS

<u>Part No.</u>	<u>Description</u>
L628	Rotating Hook Assembly, for sizes 16-4 to 30-4 thread
L629	Bobbin Case Holder, for L628
660-215	Retaining Ring, for No. 21240 C
21240 A	Quilting Guide, with right or left guide (right guide No. 21240 D, left guide No. 21240 E, bracket No. 21204 B, bushing No. 21204 C, spring No. 21240 F, retaining ring No. 660-215, screw Nos. 91, T26)
21240 B	Bracket, for No. 21240 A
21240 C	Bushing, for No. 21240 A
21240 D	Guide, right, for No. 21240 A
21240 E	Guide, left, for No. 21240 A
21240 F	Spring, for No. 21240 A
23133 F	Welt Guide, for presser foot No. L86 A
K51606	Swing-out Bracket, for plate hemmers with short bases; one each Nos. 12957 E, 22735, K51624, K51625, K51626; two each Nos. 20, 22570 (screw No. 94)
K51623	Swing-out Bracket, for plate hemmers with long bases; one each Nos. 12957 E, 22735, K51624, K51625, K51626; two each Nos. 20, 22570 (screw No. 94)
K51625	Swinging Arm, for Nos. K51606, K51623 (pivot screw No. 22735, washer No. 12957 E)
K51659	Swing-out Bracket, for dual plate hemmers on sheets (screw No. 94)
61203	Edge Guide, for machine with throat plates flush with bed (screw No. 22551 A)
61203 A	Edge Guide, for machine with raised throat plate (screw No. 22551 A)
61212	Bobbin Spool
61303 E	Three-Way Edge Guide (screw No. G26)
61413 E	Bobbin Case Assembly, for L628

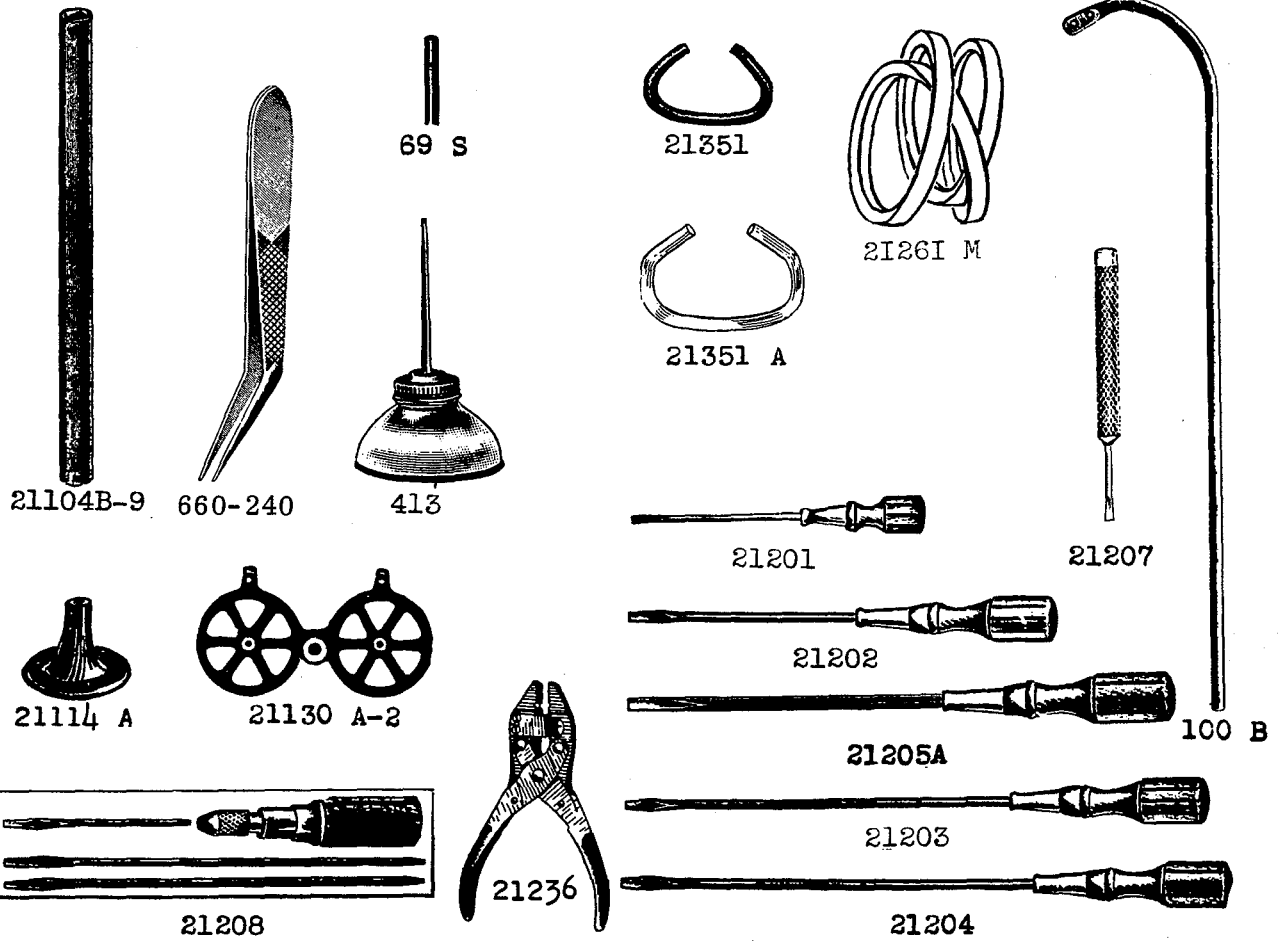
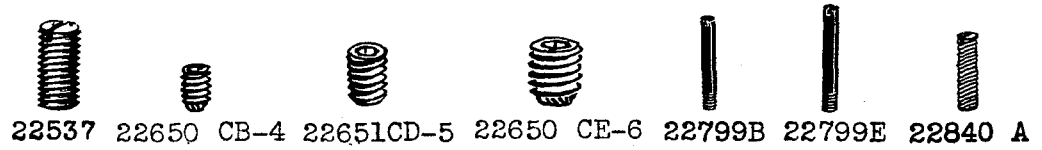
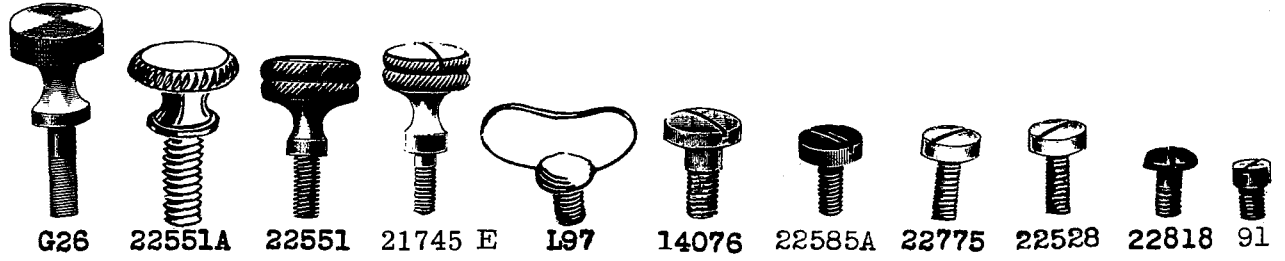
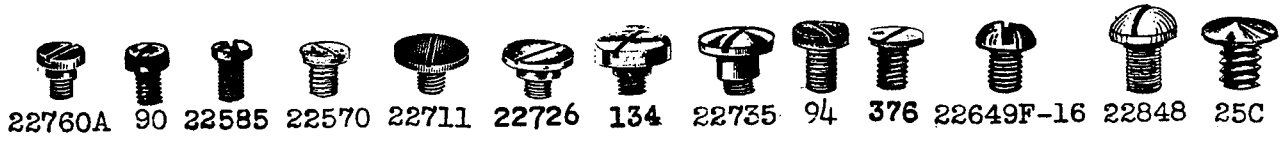
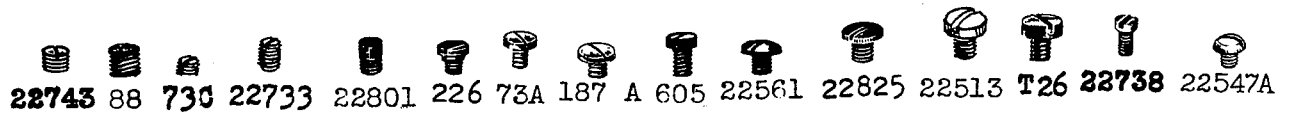

SCREWS AND MISCELLANEOUS PARTS

<u>Part No.</u>	<u>Description</u>
25 C	Screw, for attachment mounted on bed
G26	Thumb Screw, for edge guide No. 61303 E
T26	Screw, for spring No. 21240 F
69 S	Spool Pin, 4 inches long
73 A	Screw, for presser foot No. 61420 C
73 C	Lock Screw, for set screw in shank No. 61430 D
88	Attaching Screw, for No. 61420 BA
90	Attaching Screw, for plate hemmer No. L385; also for Nos. L96, L378
91	Screw, for No. 21240 C
94	Screw, for attachment No. L378; also for Nos. L122, L367
L97	Thumb Screw, for binders mounted on throat plate
100 B	Thread Stand Wire
134	Pivot Screw, for edge guide Nos. 61303, L378
187 A	Screw, for knife and spring guide No. 1741 B; also for Nos. 61220 AC, 61320 E, 61320 F, 61320 U, 61420 L, L336, L637
226	Screw, to hold spring No. L556; also for Nos. 22799 E, 35730 C, 35730 D, 35730 F
376	Screw, for throat plate
413	Oil Can
605	Screw, for presser foot guide No. L926
660-240	Thread Tweezers
14076	Pivot Screw, for arm of No. 61420 BA
21104 B-9	Thread Stand Rod, 9 inches long; also in lengths from 2 inches to 48 inches
21114 A	Thread Stand Base (two each No. 22651 CD-5)
21130 A-2	Thread Stand Seat (screw No. 22650 CE-6; two each No. 22650 CB-4)
21201	Screwdriver, 9/64 inch round blade, length over all 7 5/8 inches
21202	Screwdriver, 7/32 inch round blade, length over all 11 1/4 inches
21203	Screwdriver, 13/64 inch round blade, length over all 15 1/2 inches
21204	Screwdriver, 9/32 inch round blade, length over all 15 inches
21205 A	Screwdriver, 3/8 inch round blade, length over all 14 inches
21207	Screwdriver, 7/64 inch round blade, length over all 2 1/2 inches
21208	Screwdriver Set, three detachable blades
21236	Belt Plier, for 3/8 inch and smaller round belting
21261 M-410	"V" Belt, No. 1 size, oil resistant, 41 inches outside circumference
21261 M-420	"V" Belt, 42 inches outside circumference
21261 M-430	"V" Belt, 43 inches outside circumference
21261 M-440	"V" Belt, 44 inches outside circumference
21351	Belt Hook, wire, for 9/32 inch round belt
21351 A	Belt Hook, wire, for 3/8 inch round belt
21745 E	Thumb Screw, for presser foot
22513	Screw, for folder No. L917
22528	Screw, for feed dog holder
22537	Screw, for pulley
22547 A	Screw, for adjustable spring guide on No. 61320 N
22551	Thumb Screw, for attachments mounted on bed Nos. 61303, L378
22551 A	Thumb Screw, for attachments mounted on bed No. 61203
22561	Screw, for spring guide on presser foot No. 61429 K; also Nos. 61203 B, 61420 BA
22570	Attaching Screw, for plate hemmers used on swing-out brackets
22585	Screw, for locking lever on plate hemmer No. L96
22585 A	Screw, for edge guide No. 61303; also for Nos. 23278 K, 61203 B, L366, L377
22649 F-16	Attaching Screw, for binders Nos. K1699, L766
22650 CB-4	Screw, for thread stand wire
22650 CE-6	Screw, for thread stand seat
22651 CD-5	Screw, for thread stand base
22711	Screw, for attachments mounted on swinging bracket No. K51659
22726	Pivot Screw, for No. L32; also for Nos. 23278 K, L367
22733	Set Screw, for shank No. 61430 D
22735	Pivot Screw, for Nos. K51623, K51624
22738	Screw, for hemmer scroll No. L727; also for Nos. 61220 AA, 61420 AC, L768
22743	Screw, for locking spring No. 61420 BA
22760 A	Screw, for Nos. L127, L869
22775	Screw, for presser foot No. 61420 B
22799 B	Hinge Screw, for No. 61420 BC; also for Nos. 61420 M, L454, L903, L926
22799 E	Hinge Screw, for No. L556
22801	Hinge Screw, for No. L556; also for Nos. 35730 C, 35730 D, 35730 F
22818	Axle Screw, for roller No. 61420 BA
22825	Screw, for guide Nos. 464, 495
22840 A	Hinge Adjusting Screw, for presser foot No. L82; also for Nos. 61330 AH, 61420 AS, 61420 D, 61420 T, 61420 BT, 61420 BR
22848	Attaching Screw, rear, for swing-out guide No. 23278 K

**INSTRUCTIONS FOR ASSEMBLING ACCESSORIES 29480 AJ
OR 29480 CG & ISOLATORS 29480AK ONTO TABLEBOARDS
21371NB, 21371ND (ALL LENGTHS)**

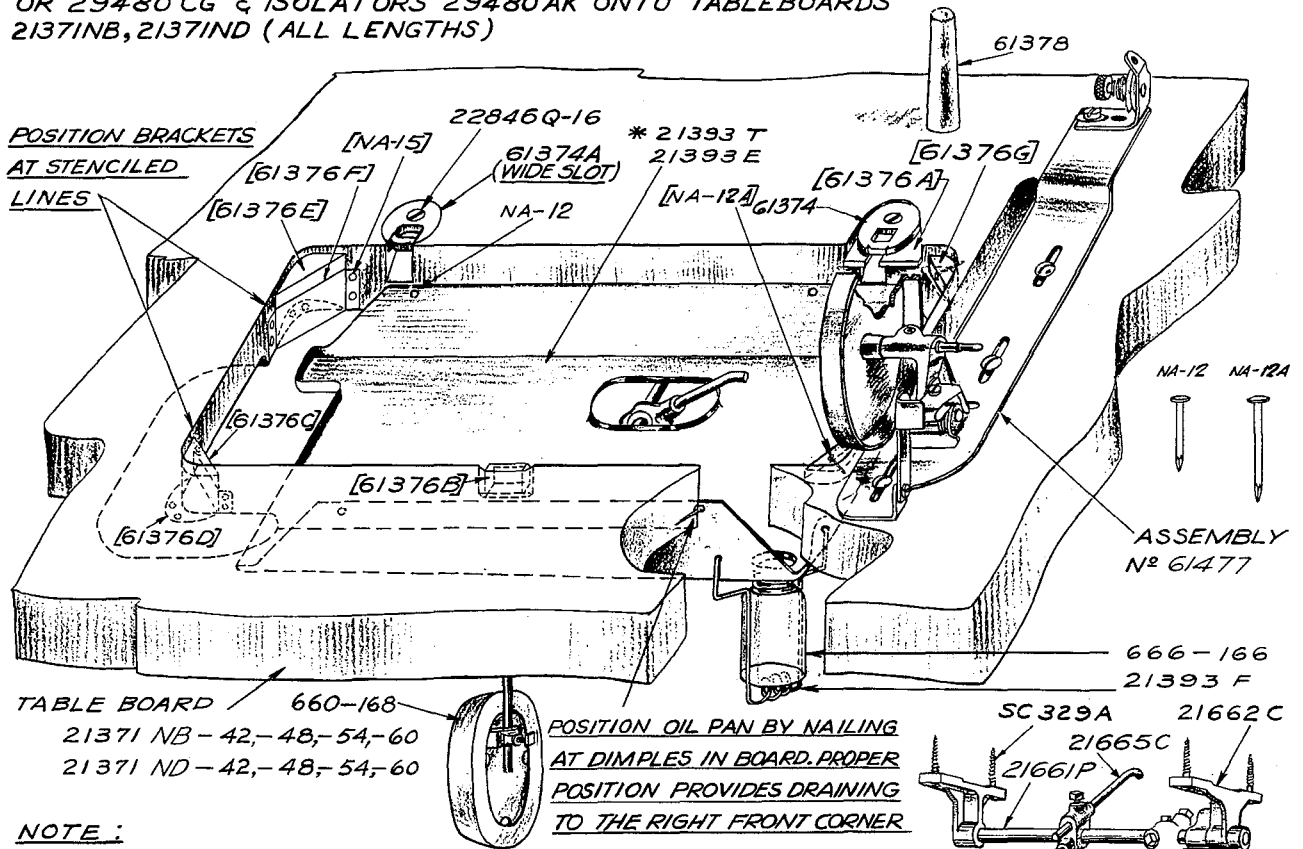

NOTE:

PART NUMBERS ENCLOSED IN BRACKETS ARE NOT INCLUDED WITH ACCESSORIES 29480AJ BUT ARE FURNISHED SEPARATELY AS 29480 AK.

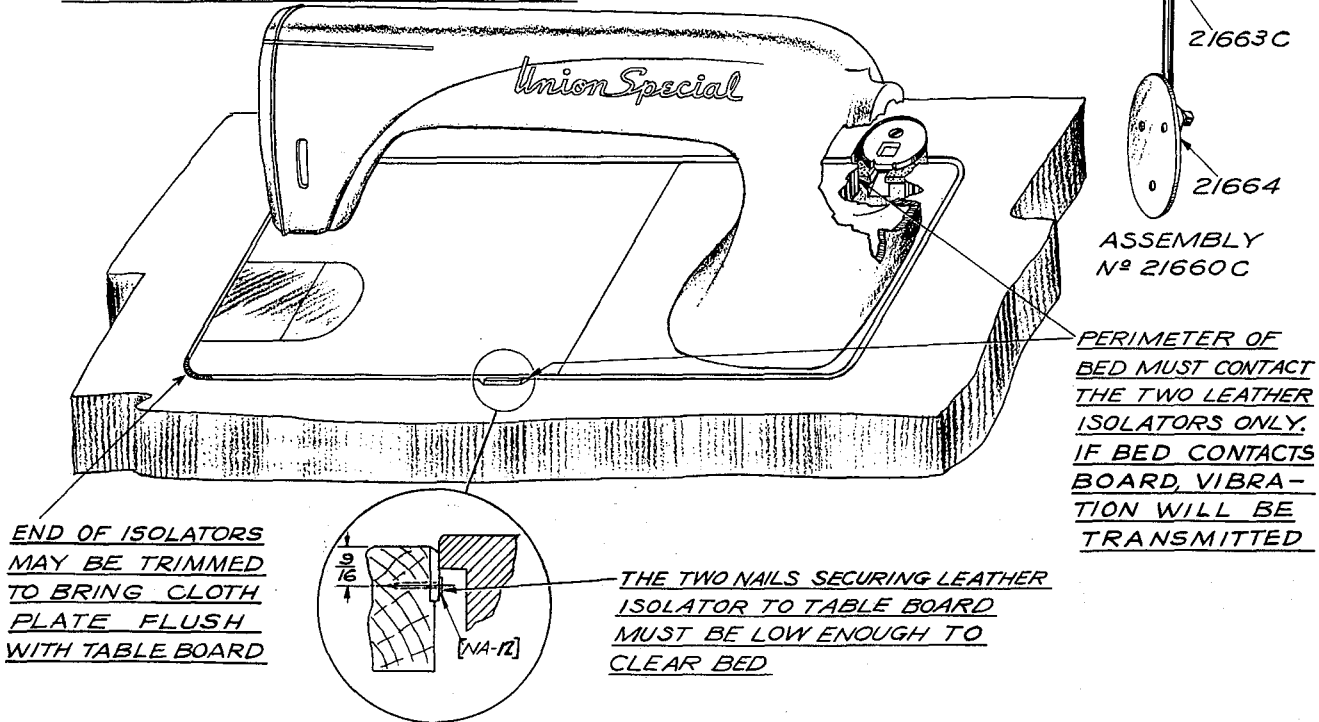

* 21393 T INCLUDED WITH 29480 CG FOR 61900 WITH PINKER

ACCESSORIES FOR 61400 MACHINES

<u>Part No.</u>	<u>Description</u>	<u>Amt. Req.</u>
29480 AJ	Accessories Assembly-----	1
NA12	Nails, for drip pan-----	4
NA12 A	Nails, for felt pads-----	4
SC329 A	Wood Screws, for knee lifter hanger-----	4
660-168	Knee Pad, rubber-----	1
666-166	Oil Drain Jar, glass-----	1
21393 E	Drip Pan-----	1
21393 F	Oil Drain Clamp Spring-----	1
21660 C	Knee Lifter Assembly-----	1
21661 P	Knee Lifter Rock Shaft-----	1
21661 D	Knee Lifter Rock Shaft Stop-----	1
69 FD	Screw-----	1
21662 C	Knee Lifter Hanger-----	2
21663 C	Knee Lifter Plate Rod-----	1
21664	Knee Lifter Plate-----	1
21665	Knee Lifter Rock Shaft Connection-----	2
69 FD	Screw-----	2
21665 C	Knee Lifter Rock Shaft Connection Arm-----	1
22846 Q-16	Flat Head Wood Screws-----	2
61374	Hinge Plate-----	1
61374 A	Hinge Plate, wide slot-----	1
61376 G	Felt Pads-----	4
61477	Bobbin Winder Assembly-----	1
61378	Machine Rest Pin-----	1

ISOLATED MOUNTING PARTS FOR 61400 MACHINES

<u>Part No.</u>	<u>Description</u>	<u>Amt. Req.</u>
29480 AK	Isolated Mounting Parts Assembly-----	1
NA12	Nails, for leather isolator pad-----	2
NA12 A	Nails, for felt pads-----	2
NA15	Nails, for securing isolated bracket to table board-----	12
61376 A	Leather Isolator Pad, rear-----	1
61376 B	Leather Isolator Pad, front-----	1
61376 C	Cork Isolator Pad, front-----	1
61376 D	Isolator Bracket, front-----	1
61376 E	Cork Isolator Pad, rear-----	1
61376 F	Isolator Bracket, rear-----	1
61376 G	Felt Pads-----	2

TABLE TOPS FOR 61400 MACHINES

(Not Illustrated)

<u>Part No.</u>	<u>Description</u>	<u>Amt. Req.</u>
21371 NB-42	Table Top, 42 x 20 x 1 3/4 inches, for isolated mounting on individual power table with "Electro Drive"-----	1
21371 NB-48	Table Top, 48 inches long-----	1
21371 NB-54	Table Top, 54 inches long-----	1
21371 NB-60	Table Top, 60 inches long-----	1
21371 ND-42	Table Top, 42 x 16 x 1 3/4 inches, for isolated mounting on open line shaft installation with transmitter No. 28636 Z-----	1
21371 ND-48	Table Top, 48 inches long-----	1
21371 ND-54	Table Top, 54 inches long-----	1
21371 ND-60	Table Top, 60 inches long-----	1
21371 RU-42	Table Top, 42 x 20 x 1 1/4 inches, for isolated mounting on E1400 pedestal-----	1

PEDESTAL ACCESSORIES FOR 61400 MACHINES

(Not Illustrated)

<u>Part No.</u>	<u>Description</u>	<u>Amt. Req.</u>
29480 BU	Kit of Parts, to adapt machines to E1400 Pedestal-----	1

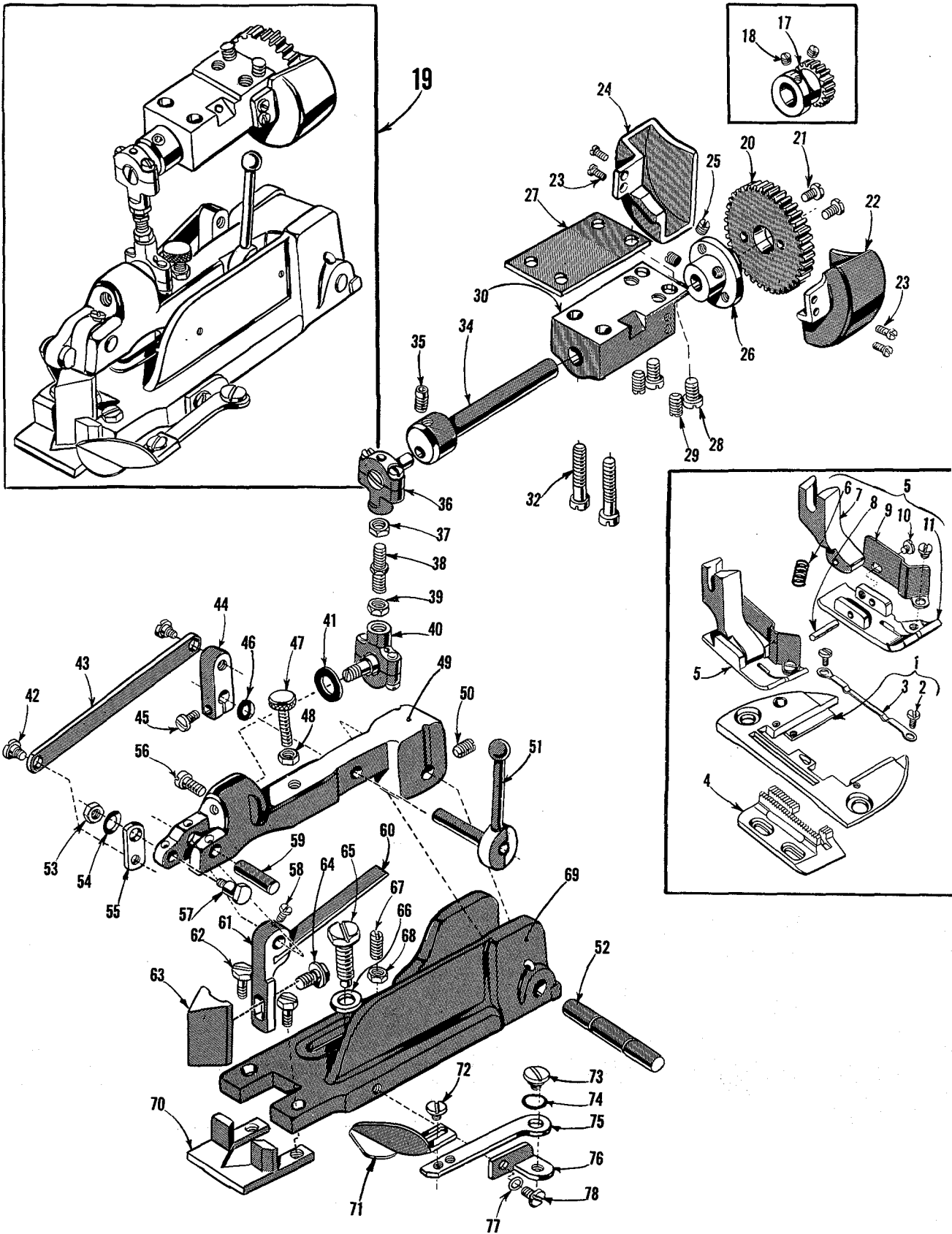

The parts illustrated on the preceding page and described on this page represent the throat plate, feed dog, presser foot and pinking attachment used on Styles 61400 G or 61400 H

Ref. No.	Part No.	Description	Amt. Req.
1	24-142	Throat Plate -----	1
2	18-261	Screw -----	2
3	8-86	Chip Guard -----	1
4	23-167	Feed Dog, 22 teeth per inch -----	1
5	405-571	Presser Foot -----	1
6	21-269	Spring -----	1
7	61330 AC	Shank -----	1
8	22-167	Hinge Pin -----	1
9	8-66	Presser Foot Guard -----	1
10	18-246	Screw -----	2
11	5-571	Bottom -----	1
17	27-164	Pinker Driving Gear -----	1
18	1025 L	Screw -----	2
19	29480 BA	Pinking Attachment, complete -----	1
20	27-68	Driven Gear -----	1
21	810 L	Screw -----	2
22	32-81	Cover, front -----	1
23	18-355	Screw -----	4
24	32-82	Cover, rear -----	1
25	1025 L	Screw -----	4
26	107-16	Flange Driven Gear -----	1
27	164-31	Shim for 50-147 -----	1
28	CS331	Screw -----	2
29	1003 L	Screw -----	2
30	50-147	Bracket, for arm -----	1
32	18-497	Screw -----	2
34	14-178	Driven Gear Shaft -----	1
35	18-1043	Screw -----	1
36	4124-32	Ball Joint, upper -----	1
37	1012 L	Nut, right hand thread -----	1
38	71-52	Connecting Rod -----	1
39	869 L	Nut, left hand thread -----	1
40	4124-33	Ball Joint, lower -----	1
41	40-57	Washer -----	1
42	1776 L	Screw -----	2
43	46-108	Link, for knife throw-out -----	1
44	45-248	Lever, for throw-out -----	1
45	18-71	Screw -----	1
46	39536 AD	Spring Washer -----	1
47	18-844	Screw -----	1
48	1160 L	Nut -----	1
49	45-247	Pinker Arm -----	1
50	1003 L	Screw, for 14-171 -----	1
51	76-18	Handle, complete, for knife throw-out -----	1
52	14-171	Shaft, for base -----	1
53	CS231	Nut, for 34-26 -----	1
54	40-101	Washer -----	1
55	45-249	Lever, for knife throw-out cam -----	1
56	CS331	Screw, for 4124-33 -----	1
57	34-26	Cam Throw-out, for upper knife -----	1
58	18-178	Screw, for 14-172 -----	1
59	14-172	Shaft, for lever -----	1
60	21-309	Flat Spring -----	2
61	99-134	Holder, for upper knife -----	1
62	18-558	Screw, for lower knife -----	2
63	119-25	Upper Knife -----	1
64	18-544	Screw, for upper knife -----	1
65	18-501	Attaching Screw, for 29480 BA -----	1
66	40-46	Washer -----	1
67	18-547	Screw -----	1
68	1012 L	Nut -----	1
69	3-46	Base -----	1
70	119-24	Lower Knife -----	1
71	475-68	Edge Guide -----	1
72	18-422	Screw -----	1
73	18-353	Screw -----	1
74	40-86	Washer -----	1
75	99-143	Edge Guide Holder -----	1
76	99-329	Holder -----	1
77	21210 A	Washer -----	1
78	810 L	Screw -----	1

NUMERICAL INDEX OF PARTS

<u>Part No.</u>	<u>Page No.</u>	<u>Part No.</u>	<u>Page No.</u>	<u>Part No.</u>	<u>Page No.</u>	<u>Part No.</u>	<u>Page No.</u>
L3	69	L119	37	L394	67	666-20	27
L11	69	L122	69	L397	43	666-104	27
NA12	79	L122 A	63	L398	43	666-126	27
NA12 A	79	L123	69	L404	61	666-127	27
NA15	79	L125	73	L405	59	666-166	79
L17	51	L127	71	L408	53	666-186	29
L17 A	65	134	77	L412	55	L683	63
18	35	L139	59	413	77	L688	69
L18	73	L143	37	L415	57	719	31
20	63	L154	69	L429	49	L719	71
CL21	29	L158	55	L433	69	L727	59
25 C	77	L160	73	L435	43	L743	59
G26	77	161	31	L436	43	L748	53
T26	77	L175	61	L437	43	L756	59
28 C	35	L179	67	L438	43	L763	69
L28	37	L180	67	L440	55	L766	73
L29	37	L184	73	L464	71	L768	49
T29	63	L186	71	L471	69	L769	49
L30	59	187 A	77	L473	59	L774	63
L32	71	L189	49	L489	69	L775	59
L33 A	41	L193	49	L495	71	L829	71
L39 A	65	L195	51	L501	71	L836	59
50-552 Blk	31	L196	67	L502	71	L868	59
50-558 Blk	27	L205	49	L503	71	L869	71
50-567 Blk	33	L206	37	L505	55	L875	57
50-568 Blk	27	L212	73	L506	49	L889	73
50-799 Blk	35	L217	49	L516	67	L900	71
L54	37	L218	51	L518	49	L903	57
L55	37	L220	55	L519	37	L909	73
HA61 D	31	L222	37	L520	37	L916	41
L64	53	L223	37	L524	71	L917	73
L67	73	226	77	L525	57	L925	65
L69	53	L229	73	L526	71	L926	65
69 S	77	L234	71	L529	53	L928	71
69 FD	79	L235	57	531	31	L936	37
L72	53	L237	57	L531	71	L943	57
73 A	77	L250	71	L546	51	L955	65
73 C	77	L265	69	L549	43	L960	57
77	29	L266	51	L550	43	1230 B	63
L77	73	L287	37	L556	57	1580 G	63
L81	73	L289	73	L563	57	1741 A	63
L82 A	51	L290	49	L564	67	1741 B	63
L83 A	43	L292	59	L566	57	2339 F	35
L86 A	55	L293	55	L567	71	3346 A	63
88	31, 33, 35, 77	L298	49	L579	37	6990	63
88 D	31	L302	67	L580	37	8372 A	29
89	27, 31, 33, 35	L310	73	L582	59	9937	29, 3
L89	73	L313	53	L599	71	12957 E	63
90	31, 77	L326	53	605	77	12987 A	35
91	77	L327	67	L610	69	14076	77
91 A	27	SC329 A	79	L627	69	15037 A	31
93	27	L336	57	L628	33, 75	15872 F	29
93 A	29, 31	L355	67	L629	33, 75	21104 B	77
94	77	L364	67	L631	67	21114 A	77
95	31, 35	L366	73	L637	67	21130 A	77
L95	53	L367	73	652 B-20	29	21201	77
96	29, 31, 35	L368	49	L653	57	21202	77
96 A	27	L369	37	L659	41	21203	77
L96	67	376	27, 35, 77	660-142	29	21204	77
L97	77	L377	73	660-168	79	21205 A	77
98	35	L378	67	660-205	29	21207	77
100 B	77	L379	71	660-215	75	21208	77
109	27	L380	57	660-225	31	21236	77
L118	37	L385	67	660-226	35	21240 A	75
		L390	71	660-240	77	21240 B	75
		L391	37	660-257	27	21240 C	75

NUMERICAL INDEX OF PARTS

Part No.	Page No.	Part No.	Page No.	Part No.	Page No.	Part No.	Page No.
21240 D.....	75	22747 B.....	35	51239 AC.....	35	61220 N.....	51
21240 E.....	75	22757 C.....	29	51239 AE.....	35	61220 P.....	53
21240 F.....	75	22758 B.....	29	51242 M.....	31	61220 Q.....	55
21261 M.....	77	22760 A.....	77	51430 F.....	63	61220 R.....	51
21351.....	77	22764 B.....	31	K51606.....	75	61220 S.....	55
21351 A.....	77	22768.....	31	K51619.....	67	61220 T.....	49
21393 E.....	79	22768 A.....	29	K51621.....	67	61220 V.....	49
21393 F.....	79	22775.....	29, 35, 77	K51622.....	69	61220 W.....	55
21657 E.....	35, 63	22775 A.....	31	K51623.....	75	61220 AA.....	59
21660 C.....	79	22799 B.....	77	K51624.....	73	61220 AB.....	49
21661 D.....	79	22799 E.....	77	K51625.....	75	61220 AC.....	57
21661 P.....	79	22799 M.....	29	K51626.....	73	61224.....	37
21662 C.....	79	22801.....	77	K51645.....	57	61224 B.....	41
21663 C.....	79	22802 A.....	31	K51649.....	69	61224 C.....	41, 47
21664.....	79	22817 A.....	29	K51650.....	69	61224 D.....	41
21665.....	79	22818.....	77	K51655.....	73	61224 E.....	39
21665 C.....	79	22825.....	77	K51659.....	75	61224 F.....	39
21745 E.....	77	22832 G.....	35	K51666.....	73	61230.....	63
22513.....	77	22840 A.....	77	K51667.....	73	61230 A.....	63
22528.....	31, 77	22845 D.....	31	K51668.....	69	61230 B.....	63
22537.....	77	22845 G.....	31	K51669.....	69	61230 C.....	63
22539 D.....	27	22846 Q-16.....	79	K51670.....	67	61230 J.....	63
22547 A.....	77	22848.....	77	K51671.....	73	61230 L.....	61
22551.....	77	22863 B.....	27	K51672.....	69	61230 M.....	61
22551 A.....	77	22874.....	35	K51677.....	73	61230 S.....	63
22560 A.....	35	22874 F.....	29	K51681.....	67	61230 U.....	63
22560 B.....	29, 35	22880.....	29, 31	K51683.....	49	61230 V.....	61
22561.....	77	22882.....	35	K51684.....	57	61230 W.....	61
22562 B.....	29	22884.....	29, 31	K51687.....	51	61230 X.....	63
22564 B.....	31, 35	22890.....	29	K51688.....	67	61230 AK.....	63
22564 E.....	33	22891.....	35	K51689.....	67	61231.....	63
22564 F.....	33	22892.....	29	K51699.....	73	61231 A.....	63
22565 C.....	35	22894 E.....	31	51930.....	63	61233 N.....	31
22569 B.....	27	22894 J.....	31	52930 T.....	63	61235.....	31
22569 C.....	33	22894 T.....	35	53678 N.....	35	61236.....	31
22569 H.....	33	22894 V.....	29	61149.....	35	61236 G.....	31
22570.....	77	22894 AB.....	29	61149 G.....	35	61242.....	33
22570 A.....	27	23133 F.....	75	61149 H.....	35	61244.....	33
22570 B.....	29	23278 K.....	73	61202.....	27	61245 G.....	27
22574.....	29	23510.....	67	61203.....	75	61246 A.....	31
22580.....	35	28618.....	63	61203 A.....	75	61248 H.....	31
22585.....	77	29126 BS.....	31	61203 B.....	73	61251 D.....	29
22585 A.....	27, 77	29126 DG.....	35	61203 C.....	73	61252 J.....	29
22596 D.....	29	29474 G.....	33	61203 D.....	73	61255.....	29
22597 A.....	27, 29	29480 AJ.....	79	61205.....	37	61255 H.....	29
22597 B.....	35	29480 AK.....	79	61205 A.....	41, 47	61256.....	29, 35
22597 E.....	27	29486 B.....	29	61205 B.....	41	61256 G.....	29
22649 F-16.....	77	35730 C.....	61	61205 C.....	41, 47	61260 A.....	31
22650 CB-4.....	77	35730 D.....	61	61205 D.....	39	61261 A.....	31
22650 CE-6.....	77	35772 H.....	63	61205 E.....	39	61263.....	31
22651 CD-5.....	77	41258.....	35	61205 CA.....	41	61264.....	31
22704.....	35	41358 M.....	35	61208 B.....	33	61264 A.....	31
22711.....	77	41358 N.....	35	61210 B.....	33	61265.....	29
22712 F.....	29	41358 P.....	35	61212.....	33, 75	61267.....	29
22716 A.....	33	41358 Q.....	35	61216.....	33	61267 G.....	29
22716 B.....	33	41358 S.....	35	61216 N.....	33	61271.....	27
22716 H.....	33	41358 T.....	35	61220.....	55	61272.....	27
22726.....	77	43443 Q.....	35	61220 B.....	59	61273.....	27
22729.....	35	51239 B.....	35	61220 C.....	61	61282 A.....	27
22730.....	27	51239 E.....	35	61220 D.....	59	61282 D.....	27
22733.....	77	51239 G.....	35	61220 G.....	51	61282 E.....	27
22735.....	77	51239 S.....	35	61220 H.....	51	61292 C.....	27
22738.....	77	51239 T.....	35	61220 J.....	51	61292 G.....	27
22742.....	27	51239 U.....	35	61220 K.....	55	61292 H.....	27
22743.....	31, 77	51239 AA.....	35	61220 L.....	59	61293.....	27
22747.....	35	51239 AB.....	35	61220 M.....	59	61293 N.....	27

NUMERICAL INDEX OF PARTS

<u>Part No.</u>	<u>Page No.</u>	<u>Part No.</u>	<u>Page No.</u>	<u>Part No.</u>	<u>Page No.</u>	<u>Part No.</u>	<u>Page No.</u>
61303	73	61324 U	43	61376 A	79	61420 B	55
61303 A	73	61330	63	61376 B	79	61420 C	51
61303 B	73	61330 B	63	61376 C	79	61420 E	49
61303 C	73	61330 C	61	61376 D	79	61420 F	49
61303 D	63	61330 E	63	61376 E	79	61420 H	55
61303 E	75	61330 F	63	61376 F	79	61420 J	65
61305	39	61330 L	61	61376 G	79	61420 K	57
61305 A	45, 47	61330 M	61	61378	79	61420 L	57
61305 B	41	61330 N	63	B61382 H	27	61420 M	55
61305 C	43	61330 P	63	61382 J	27	61420 N	49
61305 D	41	61330 Q	63	61391 C	29	61420 P	51
61305 E	39	61330 R	61	61391 D	29	61420 R	51
61305 F	41	61330 T	61	61392 F-9	27	61420 S	49
61305 G	37, 39	61330 V	61	61392 F-14	27	61420 T	55
61305 K	43, 47	61330 W	61	61393 B	27	61420 U	49
61305 M	39	61330 X	63	61393 C	27	61420 V	49
61305 N	43	61330 Y	61	61393 E	27	61420 W	59
61305 P	39	61330 Z	61	61394 L	33	61420 X	59
61305 Q	43	61330 AA	61	61394 M	33	61420 Y	59
61305 S	41	61330 AB	61	61394 P	27	61420 Z	59
61305 T	45, 47	61330 AC	63	61394 Q	27	61420 AA	65
61305 U	43	61330 AD	61	61394 R	27	61420 AB	65
61320	49	61330 AE	61	61394 Z	33	61420 AC	59
61320 B	51	61330 AF	61	61394 AA	33	61420 AD	53
61320 C	55	61330 AG	61	61394 AC	33	61420 AE	53
61320 E	57	61330 AH	63	61394 AE	27	61420 AF	53
61320 F	57	61330 AJ	61	61394 AF	33	61420 AG	51
61320 K	49	61330 AK	63	61394 AJ	33	61420 AH	49
61320 L	53	61330 AL	61	61396 F	33	61420 AJ	49
61320 M	51	61330 AM	61	61405 A	47	61420 AK	51
61320 N	57	61330 AN	61	61405 B	47	61420 AL	51
61320 P	51	61330 AP	63	61405 C	45	61420 AM	51
61320 Q	53	61330 AR	61	61405 E	47	61420 AN	55
61320 R	51	61330 AS	61	61405 F	47	61420 AP	55
61320 S	53	61330 AU	61	61405 G	45, 47	61420 AR	55
61320 U	57	61330 AV	63	61405 H	45	61420 AS	55
61320 V	57	61330 AW	61	61405 J	39	61420 AT	55
61320 X	65	61330 AX	61	61405 K	45	61420 AU	57
61320 Z	53	61336 U	31	61405 L	39	61420 AV	51
61320 AA	53	61336 Y	31	61405 M	39	61420 AW	51
61320 AB	51	61339 D	35	61405 N	45	61420 AX	53
61320 AC	49	61339 E	35	61405 P	39	61420 AY	53
61320 AD	53	61339 F	35	61405 R	39	61420 AZ	53
61320 AE	57	61339 H	35	61405 S	45, 47	61420 BA	53
61320 AF	51	61339 S	35	61405 T	45	61420 BB	57
61320 AG	55	61340 C	33	61405 U	39	61420 BC	55
61320 AH	55	61341 C	27	61405 V	37	61420 BD	57
61320 AJ	55	61341 D	27	61405 X	41	61420 BE	49
61320 AL	65	61341 G	33	61405 Y	37	61420 BG	49
61320 AM	65	61341 J	33	61405 Z	41	61420 BH	51
61321 J	29	61348 A	31	61407 B	33	61420 BJ	51
61321 L	29	61351 C	29	61407 C	33	61420 BK	65
61322 B	29	61351 J	27	61411 A	33	61420 BN	55
61324	39	61351 K	29	61413 B	75	61420 BR	55
61324 A	45, 47	61351 Q	29	61413 E	33, 75	61420 BT	57
61324 B	41	61356	29	61413 F	33	61421	29
61324 C	43	61360	29	61413 G	33	61421 A	29
61324 D	41	61360 G	31	61414	33	61424 A	47
61324 E	39	61366 C	29	61414 A	27	61424 B	47
61324 F	39	61368	29	61414 C	33	61424 C	45
61324 J	43, 47	61368 A	29	61415	33	61424 E	47
61324 L	39	61368 E	29	61415 A	33	61424 F	47
61324 N	43	61368 F	29	61417	29	61424 G	45, 47
61324 P	39	61374	79	61417 C	35	61424 H	45
61324 Q	43	61374 A	79	61420	55	61424 J	39
61324 R	45, 47	61375	27	61420 A	55	61424 K	45

NUMERICAL INDEX OF PARTS

<u>Part No.</u>	<u>Page No.</u>	<u>Part No.</u>	<u>Page No.</u>	<u>Part No.</u>	<u>Page No.</u>	<u>Part No.</u>	<u>Page No.</u>
61424 L.....	39	61434 G.....	31	61439 AJ.....	35	61457 C.....	27
61424 M.....	39	61437 A.....	31, 35	61439 AV.....	35	61457 E.....	35
61424 N.....	45	61437 B.....	31	61443.....	31	61457 F.....	35
61424 P.....	39	61437 C.....	31, 35	61445.....	31	61457 G.....	35
61424 R.....	39	61437 U.....	35	61447.....	31	61458.....	29
61424 S.....	45, 47	61438 A.....	31	61449.....	31	61458 A.....	29
61424 T.....	45	61439.....	31	61449 A.....	31	61459 A.....	29
61424 U.....	39	61439 A.....	31	61449 B.....	31, 35	61459 B.....	29
61424 X.....	41	61439 F.....	35	61449 E.....	31	61466 A.....	29
61424 Y.....	37	61439 G.....	35	61449 F.....	31	61468.....	29
61430 A.....	63	61439 H.....	35	61449 G.....	31	61470.....	27
61430 B.....	63	61439 K.....	35	61449 H.....	27	61470 B.....	27
61430 C.....	61	61439 M.....	35	61449 L.....	35	61477.....	79
61430 L.....	63	61439 N.....	65	61449 AA.....	35	61490.....	27
61430 M.....	63	61439 P.....	35	61453.....	27	61490 A.....	27
61430 N.....	63	61439 R.....	35	61453 B.....	29	61492.....	27
61430 P.....	63	61439 S.....	65	61454.....	27	61492 A.....	27
61432 A.....	31	61439 T.....	35, 65	61454 A.....	29	61494.....	33
61432 B.....	27	61439 U.....	65	61454 B.....	29	61494 A.....	33
61432 C.....	27	61439 V.....	65	61454 D.....	29	61494 B.....	33
61432 D.....	27	61439 W.....	65	61457.....	29	61494 U.....	33
61432 E.....	27	61439 X.....	65	61457 B.....	29	62262.....	31
61434.....	31						

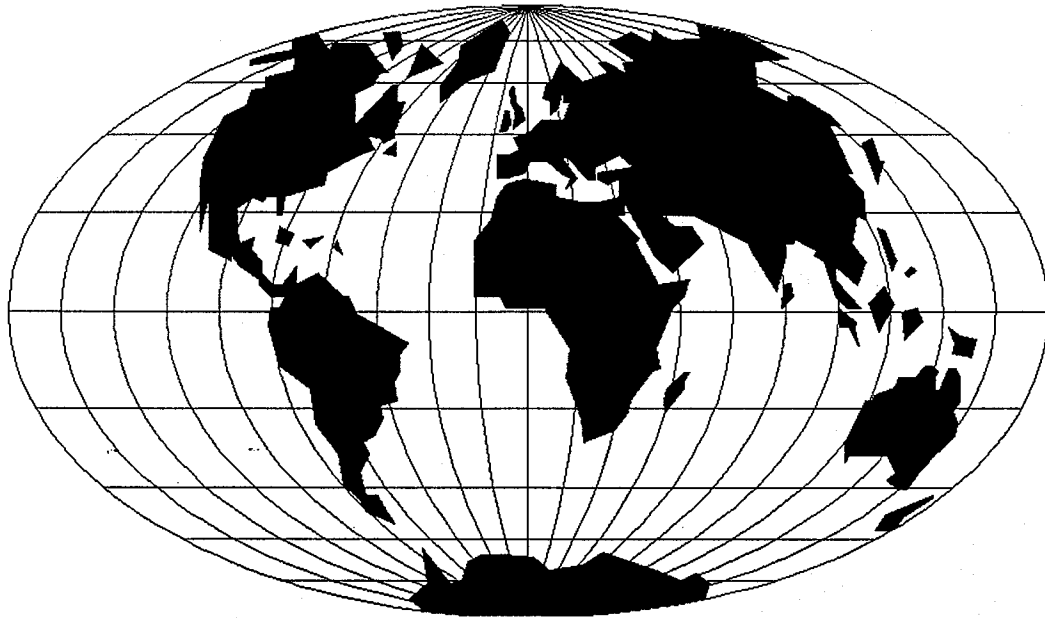

WORLDWIDE SALES AND SERVICE

Union Special Corporation maintains sales and service facilities throughout the world. These offices will aid you in the selection of the right sewing equipment for your particular operation. Union Special Corporation representatives and service technicians are factory trained and are able to serve your needs promptly and efficiently. Whatever your location, there is a qualified representative to serve you.

Corporate Office: One Union Special Plaza
Huntley, IL 60142
Phone: 847•669•5101
Fax: 847•669•4454

European Distribution Center: Union Special GmbH
Raiffeisenstrasse 3
D-71696 Möglingen, Germany
Tel: 49•07141•247•0
Fax: 49•7141•247•100

Brussels, Belgium
Charlotte, N.C.
El Paso, TX
Hong Kong, China
Huntley, IL
Leicester, England
Lille, France
Miami, FL
Milan, Italy
Möglingen, Germany
Montreal, Quebec
Osaka, Japan
Santa Fe Springs, CA

Other Representatives throughout all parts of the world.



Union Special
INDUSTRIAL SEWING EQUIPMENT